

Features & Benefits

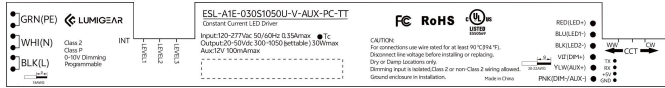

- Universal AC Input Voltage(120-277VAC)
- Linear form factor, Side feed, Metal sheet case(White)
- One Isolated 0-10V dimming interface, dim down to true 1%
- Low standby power, <0.6W@120VAC
- Flicker free, excellent camera compatibility, spec-grade smoothness
- Suitable for indoor use
- Operating temperature: -30°C~+50°C
- Comply with UL8750 Class 2, IEEE1789,
- UL Class P



Programmable feature:

- ◆ Output current at each position of INT switch, Dim to off, Min Dimming Level
- ◆ LED Thermal Protection

Model List

Model Name	Rated Input Voltage	Max Output Power(Total)	Output Current(Total)	Rated Output Voltage	Efficiency	Dimension
ESL-A1E-030S1050U-V-AUX-PC-TT	120-277VAC	30W max.	300-1050mA	20-50VDC	87%	280*30*21.5 mm 11*1.2*0.8 in.

Optional Function

Aux power, 100mA/12V

Built in 3INT and 3CCT selection switch

Approvals



Model name code

ESL-A1E	-	030S	1050	U	-	V	-	AUX	-	PC	-	T	T
①		②	③	④		⑤		⑥		⑦		⑧	⑨

①	Series	ESL Series
②	Output power	Maximum output power: 30W
③	Output current(max)	Maximum output current: 1050mA
④	Input voltage	U=120-277VAC M=120-347VAC
⑤	Dimming Control	0-10V
⑥	AUX	AUX: with Auxiliary source BLANK:without Auxiliary source
⑦	Programmable	USB-PC
⑧	INT switch function	BLANK: without INT switch "T": with 3INT switch,
⑨	CCT switch function	BLANK: without CCT switch "T": with 3CCT switch,

Specification:

Parameters	Symbols	Test Conditions / Comment	Min	Typ	Max	Units							
INPUT													
Input Voltage	V_{IN}		108		305	V_{AC}							
Rated Input Voltage	$V_{IN RATED}$		120		277	V_{AC}							
Input Frequency	f_{line}		47	50/60	63	Hz							
Input Current	I_{IN}	Full Load, $V_{IN} = 120V_{AC}$			0.35	A							
Inrush Current	I_{INRUSH}	Cold Start, $V_{IN} = 277V_{AC}$			40	A							
Leakage Current	$I_{Leakage}$	$V_{IN} = 277V_{AC}$ 60Hz			0.75	mA							
Number of Drivers per MCB(Circuit Breaker)	MCB type	B10	C10	D10	B13	C13	D13	B16	C16	D16	B20	C20	D20
	120V _{AC}	19	22	26	25	29	34	31	36	41	39	45	52
	277V _{AC}	13	22	44	17	29	58	21	35	71	26	44	89

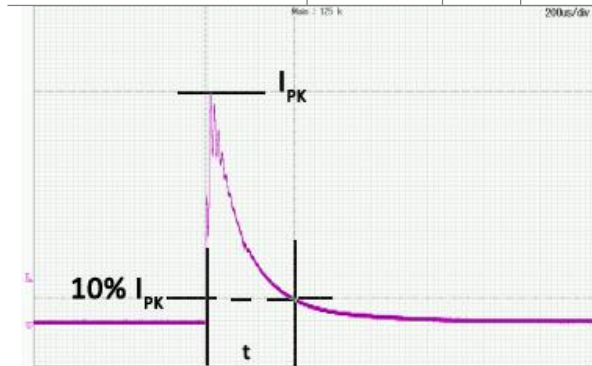

Input Voltage	Inrush Current	t(µs)10%-10%
120VAC	15.08A	168
277VAC	29.35A	186
347VAC	NA	NA

General Characteristics

Power Factor	PF	20-100% load, $V_{IN} = 120V_{AC}$	0.95		PF	
		50-100% load, $V_{IN} = 277V_{AC}$	0.9			
Total Harmonic Distortion	THD	20-100% load, $V_{IN} = 120V_{AC}$		20	%	
		50-100% load, $V_{IN} = 277V_{AC}$		20	%	
Efficiency	η	$V_{out}=42.8V$, $I_{out}=700mA$, $V_{IN} = 120V_{AC}$, steady state	85	87	%	
		$V_{out}=42.8V$, $I_{out}=700mA$, $V_{IN} = 277V_{AC}$, steady state	86	88	%	
Turn On Delay Time	$T_{on, delay}$	Cold Start, 300-1050mA			0.75	S

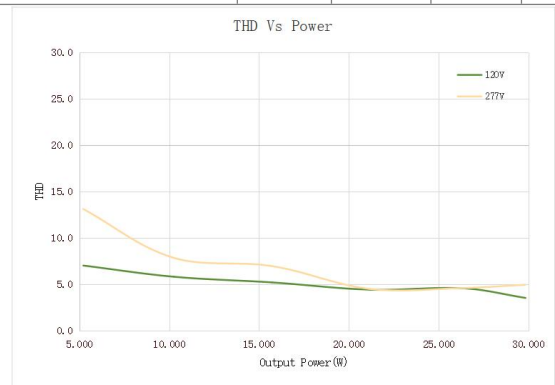
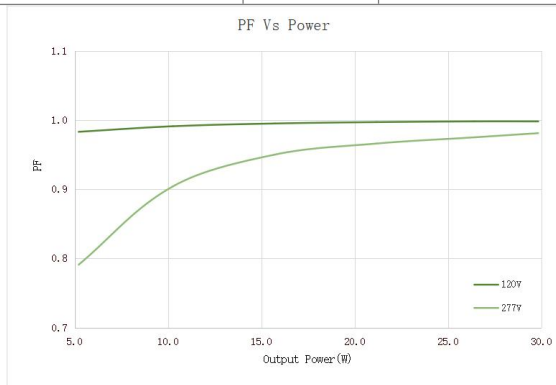

OUTPUT

Output current tolerance	t	$I_{OUT}=300-1050mA$			5	%
Output current range	I_{OUT}		300		1050	mA
Output Voltage	V_{OUT}		20		50	V
Output Power	P_{OUT}				30	W
Line Regulation	$V_{OUT-LINE}$				1	%
Load Regulation	$I_{OUT-LOAD}$	V_{OUT} from MIN. to MAX.			3	%
Ripple Current	$I_{OUT-RIPPLE}$	Full Load, $(I_{omax}-I_{omin})/(I_{omax}+I_{omin})$, Flicker free			10	%
Output Current Overshoot	$I_{OVERSHOOT}$	Turning Power ON			10	%

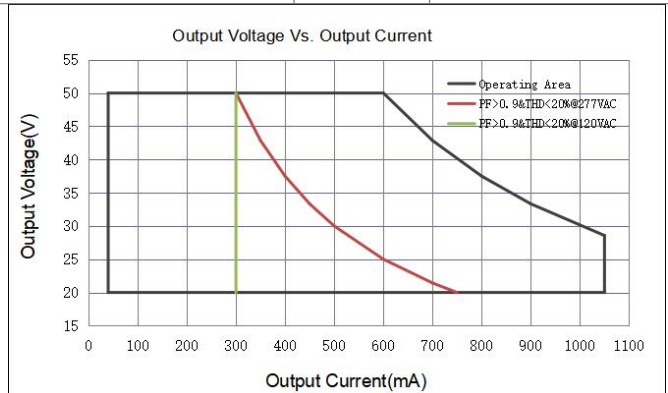

Programming

The driver can be programmed. Please contact LUMIGEAR for details.

- Dim to off, Min Dimming Level
- LED thermal protection
- Dimming Curve:Log/linear/square
- Output current at each position of INT switch

The driver can recognize the type of input signal, analog or digital. So the driver can be easily connected to a digital control system, or can be connected to an external NTC / rheostat / current selection switch to set the driver(eg: output current , dimming curve, and so on).

Interface-Terminal block	Programming software	“LUMIGEAR Programming Tool”				
	Programming tool	“Lumigear tool box”				
	Operating voltage			5	5.5	V
	Pull up resistor	TX are pulled up to +5V		62K		Ohm
		RX is pulled up to +5V		15K		Ohm
	+5V Aux power				10	mA



0~10V or Resistor Dimming

The 0~10V or resistor dimming can be used to dim the output Current via a standard commercial wall dimmer (0~10V_{dc}) or an external control voltage source (0~10V_{dc}) or external resistor.

Dimming Curve	Selectable Log/linear/square , default: Linear, please see "Dimming curve".				
Absolute Maximum Voltage on 0~10V Pin	V _{DIM}		0	300	V
Source Current on 0~10V Dimming Pin	I _{DIM}		200		uA
Light On	V _{DIM-on}	Programmable		0.9	V
Light Off	V _{DIM-off}	Programmable		0.7	V
Clamp Voltage	V _{DIM-Clamp}	Programmable		1	V
Dimming Voltage for Full Bright	V _{DIM-MAX}	Programmable		8	V
Standby power	P _{STANDBY}	Light Off, V _{IN} =120V		0.6	W

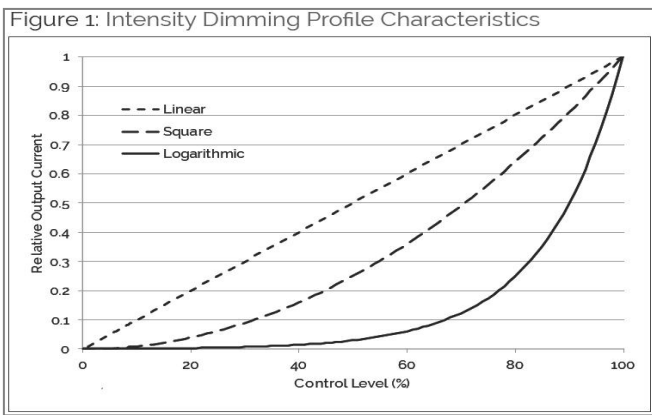
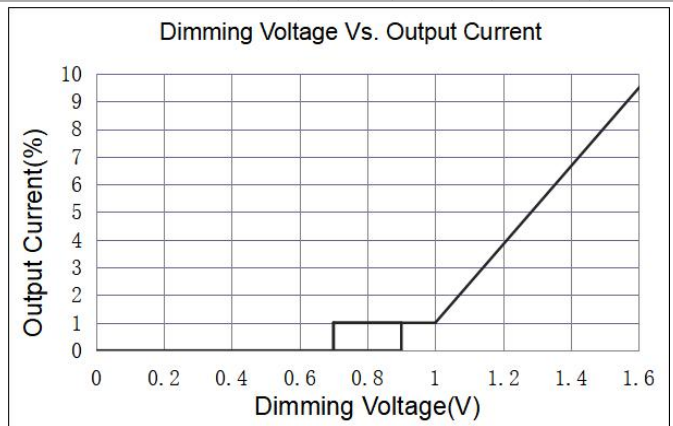
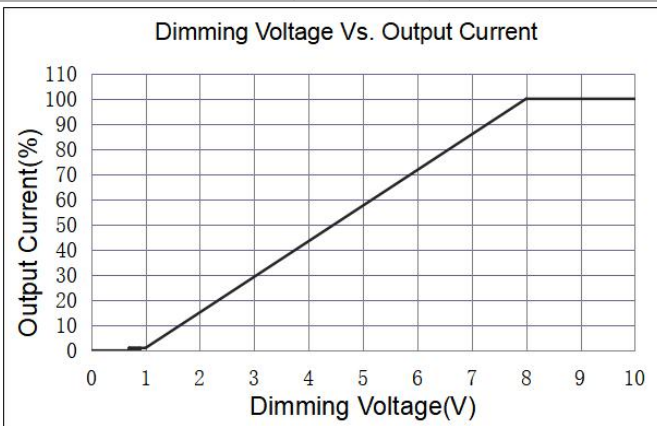

INT(output current) selection(Optional)

Built-in INT selection switch | 3/4/5 positions, Programmable at each position

Build in CCT selection (Optional)

Built-in CCT selection switch | 3/4/5 positions

LED Thermal Protection (NTC) Characteristic

The LED thermal protection feature of the driver helps reduce the temperature of the LED module by reducing dual output current together in case of abnormal temperature conditions.

In the end application, care must be taken to place the NTC thermistor close to the hottest spot on the LED module.

If LED thermal protection is not required the NTC port on the LED power supply connector can be left open.

Graphs for reference. The derating limits can be programmed using the Light Touch. Please contact adpower for details.

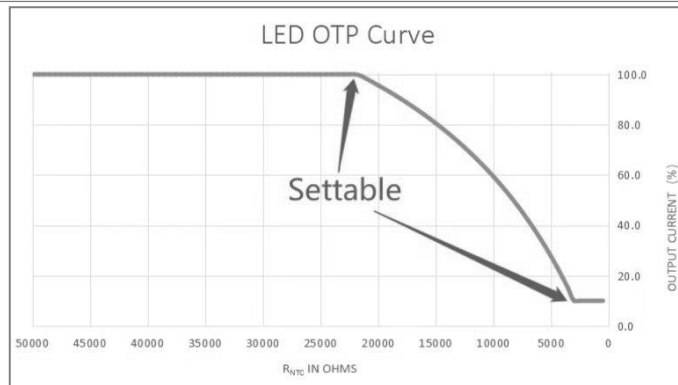

Auxiliary source (Optional)

Voltage range	V_{AUX}		11	12	13	Vdc
Max.power	P_{AUX}				1.2	W
Over load protection	P_{AUX_OLP}	CC/CV Mode			1.6	W

Protection

Over Voltage Protection	V_{OVP}	Recover automatically after fault conditions is removed.			60	V
Over Temp. Protection	T_{OTP}	Current linear decrease at hotspot greater than T_{OTP}		90		°C
Short Circuit Protection	The driver can recover automatically after fault conditions is removed.					

Environment

Storage Temperature	$T_{Storage}$	Humidity: 5% RH to 95% RH	-40	-	+85	°C
Ambient Operating Temperature	T_a		-30	-	+50	°C
Max. Case Temperature	T_c	Hot spot on case			85	°C
Operating Relative Humidity	H_a	Non-Condensing	10		90	%
Acoustic Noise		Measured from 1m away.			24	dBA
Cooling	Convection Cooling					
IP Rating	Dry and damp UL approved					

Others

Life Time	T_{Life}	Full Load, 80°C case temperature,	50			kHrs
MTBF	T_{MTBF}	Full Load, 25°C ambient temperature	200			kHrs
Net Weight	W_{NET}			210		g

Warranty | 5 Years Warranty at $T_c \leq 80^\circ\text{C}$

Flicker | Title 24 and IEEE 1789, Title 24

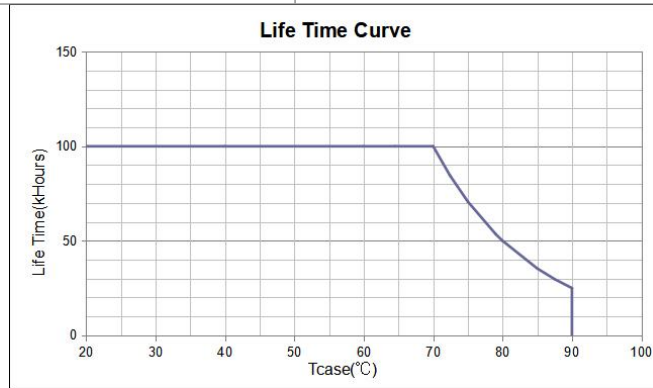

Safety Compliance

CUL/UL | UL8750, CAN/CSA-C22.2 No. 250.13

Electromagnetic Compliance

EMC Requirements	Standard	Conditions
EMI Emissions	FCC Title 47 Part 15B	Class B at $120V_{AC}$, Class A at $277V_{AC}$
Voltage Fluctuations and Flicker	IEC61000-3-3	
Immunity Compliance	IEC 61000-4-2	$\pm 8\text{kV}$ air Discharge, $\pm 6\text{kV}$ Contact Discharge
	IEC 61000-4-5	$\pm 2\text{kV}$ Common and Differential(2ohm) Mode
	ANSI/IEEE C62.41.1-2002	2.5kV Ring Wave, test at 30Ω 7 Strikes/1 minute interval, Common and Differential mode, 56 total strikes
	IEC 61000-4-11	>95% dip, .5 period; 30% dip, 25 periods; 95% reduction, 250 periods
	IEC 61000-4-4	$\pm 2\text{kV}$ Direct couple to Line input, 5kHz repetition rate, 15mS duration, 300mS period. 7 coupling paths, 1 minute per path (14 total combinations)

Note: Unless otherwise specified, all the above parameters are measured at ambient temperature of 25°C and rated voltage.

Typical Applicatio

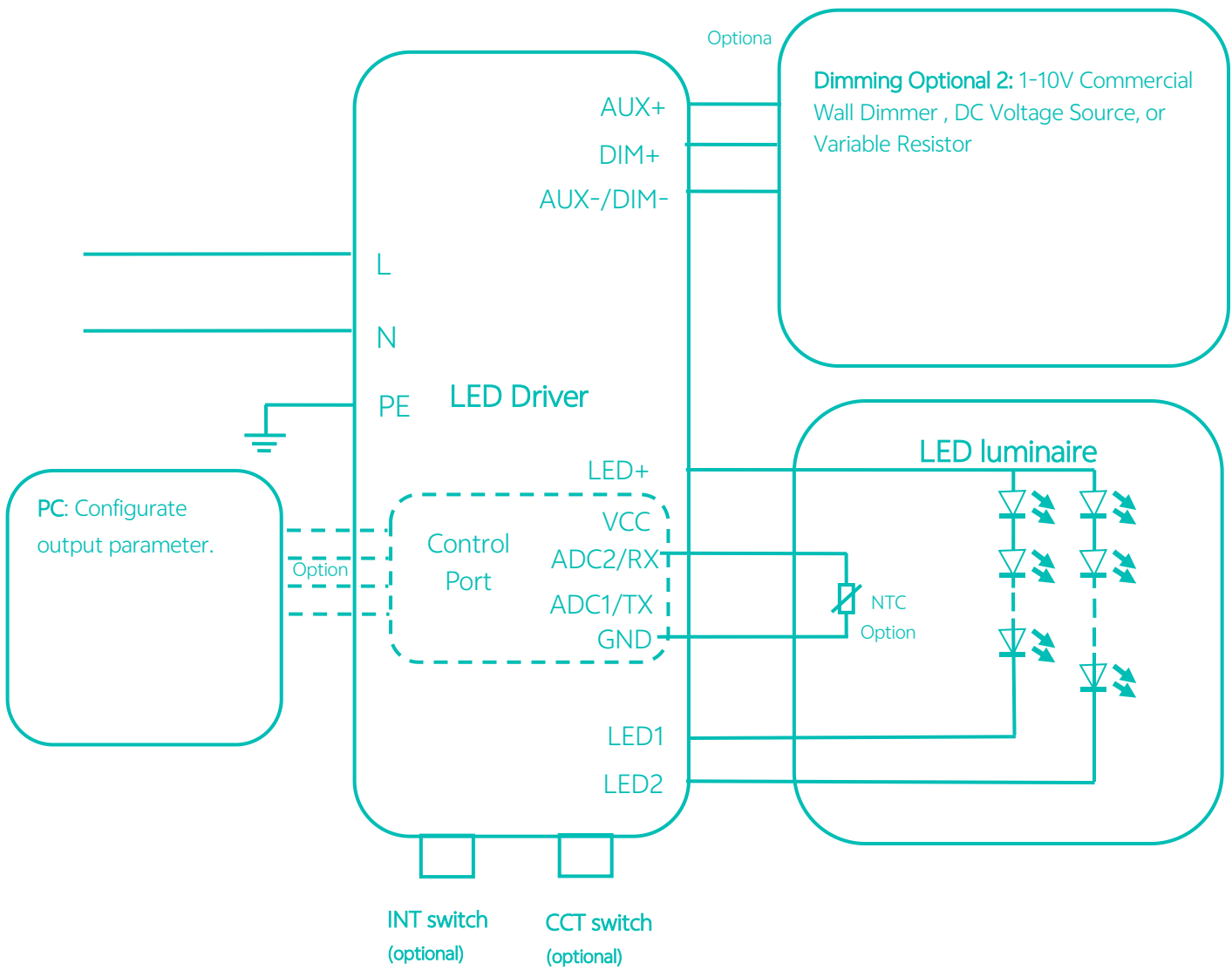

Packaging

Driver quantity (pcs)	Layer	Weight (kg)	Outer dimensions of Carton L*W*H(mm)
63	7	14	330 X 305 X 210

Mechanical Drawing:

