

Features & Benefits

- Universal AC input voltage(120-277VAC)
- High power density design, white aluminum sheet metal case
- Comply with phase cut dimming and isolated 0-10V dimming, dim down to true 1%
- Suitable for indoor use
- Flicker free, excellent camera compatibility
- UL Class2, Class P
- Combination Wave 2KV, Ringwave 2.5KV
- Operating temperature: -25°C~+50°C
- Comply with IEEE1789, UL8750

Programmable feature:

- ◆ Output current(1ma step)
- ◆ Dim to off, min dimming level
- ◆ Programmable conduction angles with turn-on & turn-off for triac & elv
- ◆ Dimming curve: Log/linear/square dim curves
- ◆ Otp mode: Foldback mode, linear decrease mode
- ◆ Dimming fade time
- ◆ Over load protection

Model List

Model Name	Rated Input Voltage	Max Output Power(Total)	Output Current(Total)	Rated Output Voltage	Efficiency	Dimension
AFP-B1-012S0420U-VT-AUX-PC	120-277VAC	12W max.	42-420mA	10-42VDC	85%	85*40.5*27mm/ 3.3×1.6×1.1 in.
AFP-B1-025S0850U-VT-AUX-PC	120-277VAC	25W max.	85-850mA	10-42VDC	87%	85*40.5*27mm/ 3.3×1.6×1.1 in.
AFP-B1-040S1200U-VT-AUX-PC	120-277VAC	40W max.	120-1200mA	10-42VDC	88%	85*40.5*27mm/ 3.3×1.6×1.1 in.

Optional Function

· Aux power, 50mA/12V

Approvals

TRIAC

0/1-10 V



CLASS P

Model name code

AFP-B1	=	012S	0420	U	=	VT	=	AUX	=	PC
①		②	③	④		⑤		⑥		⑦

①	Series	AFP Series
②	Output power	Maximum output power:12W
③	Output current(max)	Maximum output current:420mA

④	Input voltage	120-277VAC
⑤	Dimming Control	Triac&0-10V
⑥	AUX	AUX: with Auxiliary source BLANK:without Auxiliary source
⑦	Programmable	USB-PC

Specification:

Parameters	Symbols	Test Conditions / Comment	Min	Typ	Max	Units							
INPUT													
Input Voltage	V_{IN}		108		305	V_{AC}							
Rated Input Voltage	$V_{IN RATED}$		120		277	V_{AC}							
	$V_{IN RATED_TRIAC}$	Phase Cut Dimming		120		V_{AC}							
Input Frequency	f_{line}		47	50/60	63	Hz							
Input Current	I_{IN}	AFP-B1-012, Full Load, $V_{IN} = 120V_{AC}$			0.15	A							
		AFP-B1-025, Full Load, $V_{IN} = 120V_{AC}$			0.28	A							
		AFP-B1-040, Full Load, $V_{IN} = 120V_{AC}$			0.44	A							
Inrush Current	I_{INRUSH}	Cold Start, $V_{IN} = 277V_{AC}$			30	A							
Leakage Current	$I_{Leakage}$	$V_{IN} = 277V_{AC}$ 60Hz			0.75	mA							
Number of Drivers per MCB(Circuit Breaker)	MCB type	B10	C10	D10	B13	C13	D13	B16	C16	D16	B20	C20	D20
	120V _{AC}	13	15	17	17	20	22	21	24	28	26	30	35
	277V _{AC}	9	15	31	39	20	40	15	25	50	18	31	62

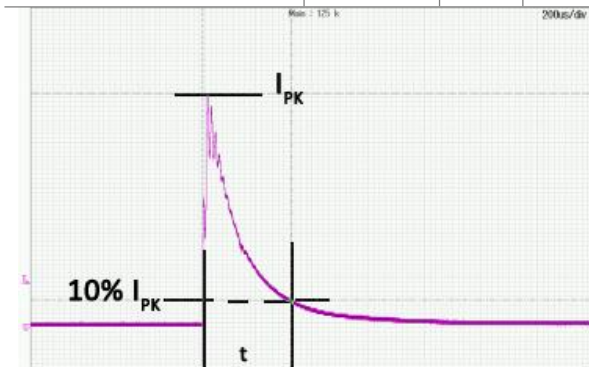

Input Voltage	Inrush Current	t(us)10%-10%
120VAC	12.1A	200
277VAC	25.5A	190
347VAC	NA	NA

General Characteristics



Power Factor	PF	20-100% load, $V_{IN} = 120V_{AC}$	0.9		PF
		40-100% load, $V_{IN} = 277V_{AC}$	0.9		
Total Harmonic Distortion	THD	20-100% load, $V_{IN} = 120V_{AC}$		20	%
		40-100% load, $V_{IN} = 277V_{AC}$		20	%
Turn On Delay Time	T_{on_delay}	Cold Start, Without Dimmer		0.5	S
		Cold Start, 1% current output		1.0	S
Efficiency	η	AFP-B1-012, $I_{OUT}=300mA$, $V_{IN}=120V_{AC}$, Steady state	83	85	%
		AFP-B1-025, $I_{OUT}=625mA$, $V_{IN}=120V_{AC}$, Steady state	84	86	%
		AFP-B1-040, $I_{OUT}=1000mA$, $V_{IN}=120V_{AC}$, Steady state	85	87	%
		AFP-B1-012, $I_{OUT}=300mA$, $V_{IN}=277V_{AC}$, Steady state	82	84	%
		AFP-B1-025, $I_{OUT}=625mA$, $V_{IN}=277V_{AC}$, Steady state	85	87	%
		AFP-B1-040, $I_{OUT}=1000mA$, $V_{IN}=277V_{AC}$, Steady state	86	88	%

OUTPUT

Output Current Tolerance	t				5	%
Output Voltage	V _{OUT}		10		42	V
Line Regulation	V _{OUT-LINE}				1	%
Load Regulation	I _{OUT-LOAD}	V _{OUT} from MIN. to MAX.			5	%
Ripple Current	I _{OUT-RIPPLE}	Full Load, (I _{max} -I _{min})/(I _{max} +I _{min})			10	%
Output Current Overshoot	I _{OVERSHOOT}	Turning Power ON			10	%

Programming

The driver can be programmed through RJ9.

NO.	Item	Default Setting
1	Output current(1mA step)	See"Model list" for each model
2	Dim to off(0-10V)	Enable
3	Min Dimming Level	1%
4	0-10V Dimming curve: Log/linear/customer dim curves	See "0~10V or Resistor Dimming" section
5	Over Temperature Protection: Foldback mode, Linear decrease mode	See "Protection" section
6	Over load protection	See "Protection" section
7	Fade time	10mS
P2.0 Female Plug	Programming software	"LUMIGEAR Programming Tool"
	Programming tool	"Lumigear tool box"
	Operating voltage	
Programming Interface	PGT-USB-TPAC-A	
Programming Cables	PGT-USB-M4P2	

0~10V or Resistor Dimming

The 0~10V or resistor dimming can be used to dim the output current via a standard commercial wall dimmer (0~10V_{DC}) or an external control voltage source (0~10V_{DC}) or external resistor.

Dimming Curve	Linear. please see "Dimming curve".					
Absolute Maximum Voltage on 0~10V Pin	V _{DIM}		0		300	V _{AC}
Source Current on 0~10V Dimming Pin	I _{DIM}			200		uA
Light On	V _{DIM-on}	Programmable		0.9		V
Light Off	V _{DIM-off}	Programmable		0.7		V

Dimming Voltage for Full Bright	$V_{DIM-MAX}$	Programmable		8	V
Leakage Voltage	$V_{Leak,rms}$	Voltage between DIM- and Ground		20	V_{AC}
Standby power	$P_{STANDBY}$	Light Off		0.7	W

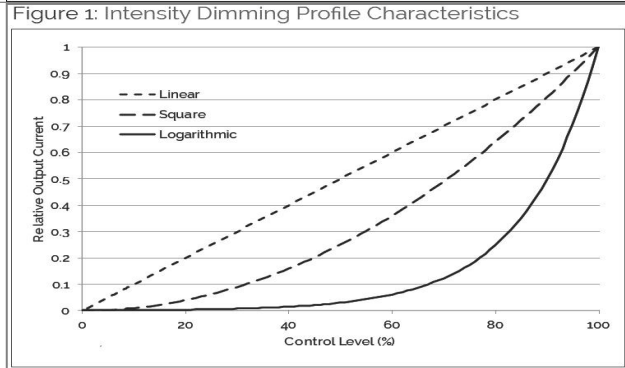
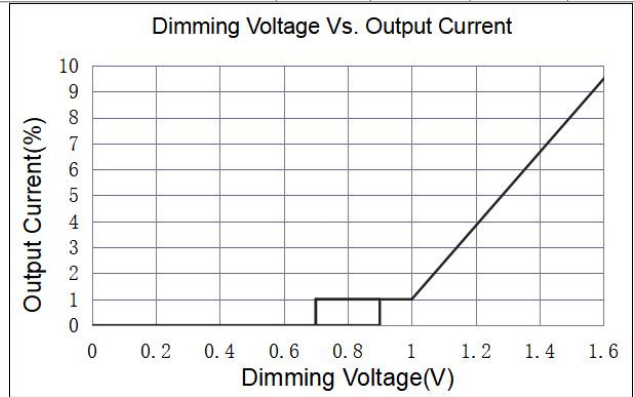
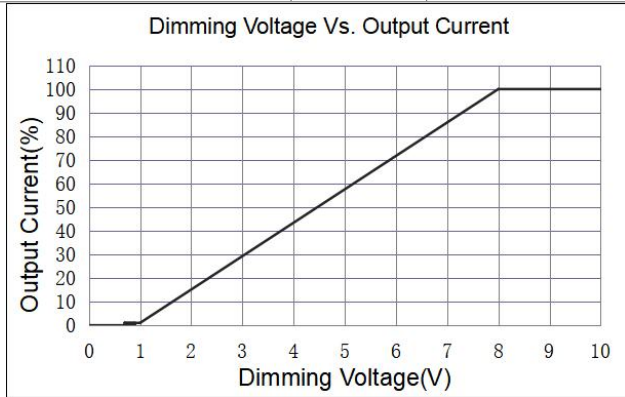

Triac Dimming

The unit is compatible With Leading-edge and Trailing-edge Dimmer.

Input Voltage	$V_{IN-TRIAC DIM}$			120	V_{AC}
Suggest Load Range	$P_{Suggest}$	$V_{IN} = 120 V_{AC}$	40	100	%

Protection

Over Voltage Protection	V_{OVP}	The unit will recover automatically after fault conditions is removed.		60	V
Over Temp. Protection	T_{OTP}	Current foldback at hotspot greater than T_{OTP}		95	°C
Over load protection	P_{OLP}	AFP-B1-012, Programmable. Output current will decrease when output power reach P_{OLP}	5	14	W
		AFP-B1-025, Programmable. Output current will decrease when output power reach P_{OLP}	10	25	W
		AFP-B1-040, Programmable. Output current will decrease when output power reach P_{OLP}	16	40	W
OLP tolerance	t_{OLP}		100	110	%
Short Circuit Protection	The unit will recover automatically after fault conditions is removed.				

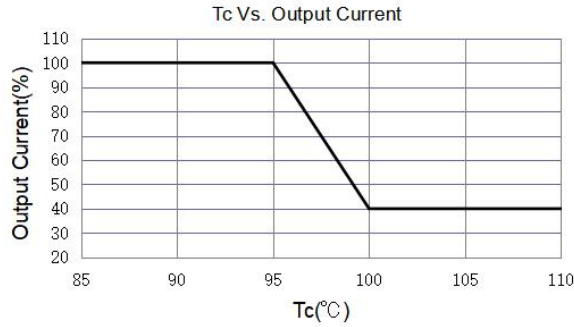

Environment

Storage Temperature	$T_{Storage}$	Humidity: 5% RH to 95% RH	-40	-	+85	°C
Ambient Operating Temperature	T_a		-25	-	+50	°C
Max. Case Temperature	T_c	Hot spot on case			90	°C
Operating Relative Humidity	H_a	Non-Condensing	10		90	%
Acoustic Noise		Measured from 1 m w/o dimmer.			24	dB(A)
Cooling	Convection Cooling					
IP Rating	Dry and damp UL approved					

Others

Life Time	T_{Life}	AFP-B1-012, Full Load, 80°C case temperature	50			kHrs
		AFP-B1-025 and AFP-B1-040, Full Load, 85°C case temperature	50			kHrs
SVAF	T_{SVAF}	Full Load, 25°C ambient temperature	200			kHrs
Net Weight	W_{NET}			160		g
Warranty	AFP-B1-012, 5 Years Warranty at $T_c \leq 80^\circ\text{C}$					
	AFP-B1-025 and AFP-B1-040, 5 Years Warranty at $T_c \leq 85^\circ\text{C}$					
Flicker	IEEE 1789, title 24					

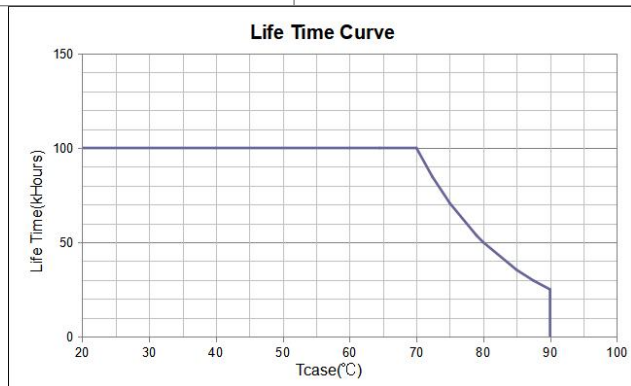

AFP-B1-012 life time curve

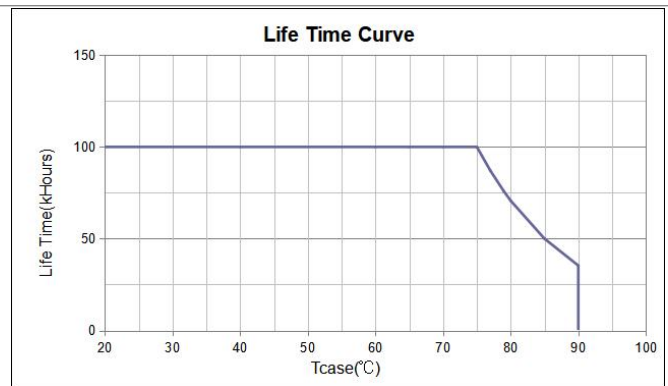

AFP-B1-025 and AFP-B1-040 life time curve

Safety Compliance

CUL/UL	UL8750, CAN/CSA-C22.2 No. 250.13
--------	----------------------------------

Electromagnetic Compliance

EMC Requirements	Standard	Conditions
EMI Emissions	FCC Title 47 Part 15	Class B at 120V _{AC} , Class A at 277V _{AC}
Voltage Fluctuations and Flicker	IEC61000-3-3	
Immunity Compliance	IEC 61000-4-2	±8kV air Discharge, ±6kV Contact Discharge
	ANSI/IEEE C62.41-2002	± 2kV Common and Differential Mode, test at 2 Ω, 5 strikes/1minute interval (40 total strikes)
	ANSI/IEEE C62.41.1-2002	2.5kV Ring Wave, test at 30Ω 7 Strikes/1 minute interval, Common and Differential mode, 56 total strikes
	IEC 61000-4-11	>95% dip, 5 period; 30% dip, 25 periods; 95% reduction, 250 periods
	IEC 61000-4-4	± 2kV Direct couple to Line input, 5kHz repetition rate, 15mS duration, 300mS period. 7 coupling paths, 1 minute per path (14 total combinations)

Note: Unless otherwise specified, all the above parameters are measured at ambient temperature of 25°C and rated voltage.

Compatible Phase Cut Dimmers:

No.	Mfg.	Model	Remark	No.	Mfg.	Model	Remark
1	Lutron	MACL-153M		12	Leviton	1B34L1	
2	Lutron	LGCL-153PL		13	Leviton	IPL06	
3	Lutron	GLU12-F23622		14	Leviton	SureSlide 6633	
4	Leviton	111506		15	Leviton	IPE04	
5	Lutron	GLV-600		16	Leviton	IPL06-102	
6	Lutron	D-600P		17	Lutron	DVCL-153P	
7	Lutron	DVLV-600P		18	Legrand	LSLV603	
8	Lutron	MALV-600		19	Legrand	RHCL453P	
9	Lutron	NT-1000		20	Lutron	1K35O2	
10	Lutron	SLV-600P		21	Lutron	DV-600P	
11	Lutron	MA-600					

Typical Application

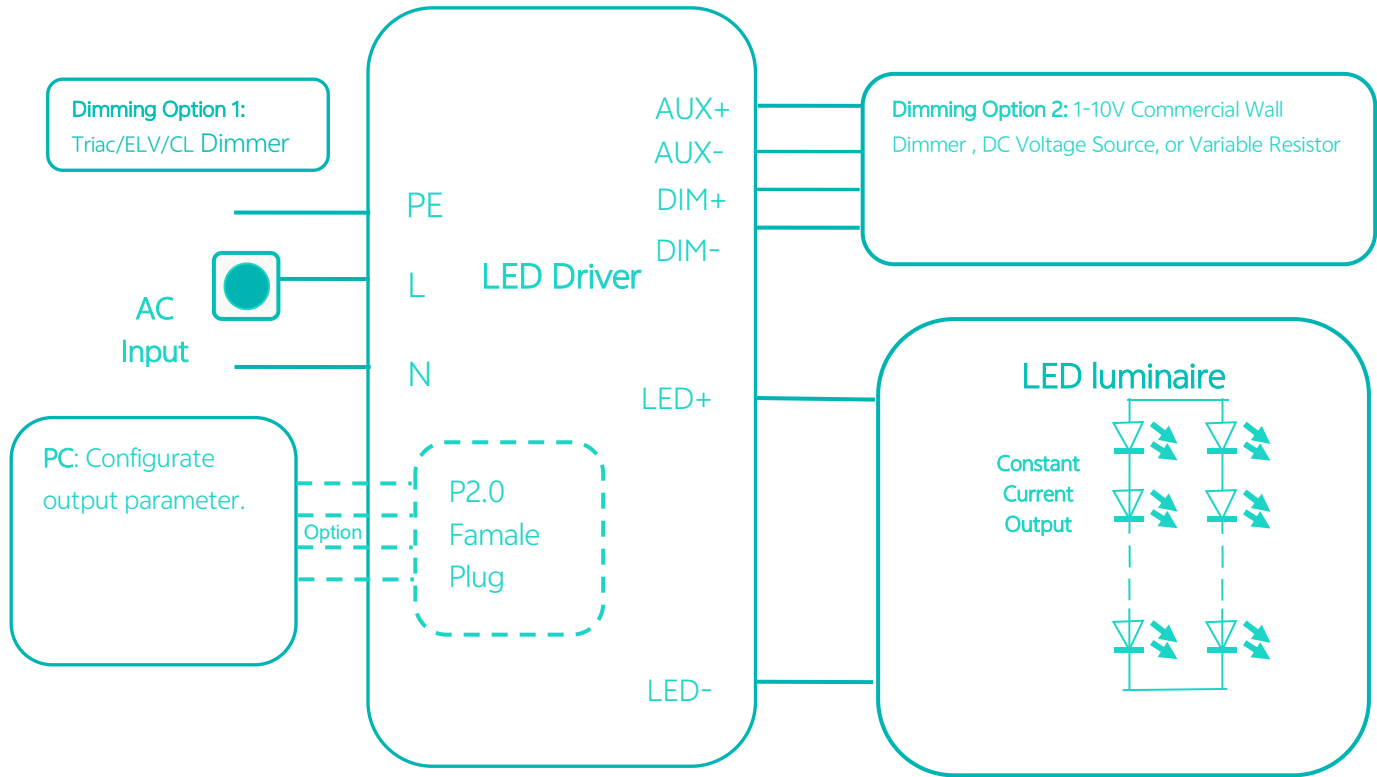

Packaging

Driver quantity (pcs)	Layer	Weight (kg)	Outer dimensions of Carton L*W*H(mm)
TBD	TBD	TBD	L365*W340*H265

Mechanical Drawing:

