

Features & Benefits

- Universal ac input voltage(120-277VAC)
- Linear form factor, metal sheet case(white), side feed
- Dimmable built-in constant current independent dual outputs LED driver, dim down to true 1%.
- DALI-2 Standard: IEC62386-101{ed2.0}-2014, IEC62386-102{ed2.0}-2014, IEC62386-207{ed2.0}-2018, IEC62386-209{ed1.0}-2011
- Max. output power 30W shared between the two channels
- Low standby power: <0.7W@120VAC
- Flicker free, excellent camera compatibility, spec-grade smoothness
- UL Class2, Class P
- Comply with IEEE1789, UL8750



• ORC(DALI+)
• ORG(DALI-)
• BLK(L)
• WH(N)
• GRN(PE)

LUMIGEAR
PDL-C1-050D1400U-DALI-PC
 Constant Current LED Driver

Class 2
 Independent Dual Outputs
 Programmable

• Tc
 Input:120-277Vac 50/60Hz 0.35Amax
 Output:18-55Vdc 140-1400mA(Selectable)
 Output:2.5-5.9A@ 140-1400mA(Selectable)
 Total Output Power:50Wmax

CAUTION:
 For connections use wire sized for at least 90°C (194°F).
 Disconnect line voltage before installing or replacing.
 Dry or damp locations only.
 Ground enclosure in installation.

OUTPUT 1: BLU+ 18-55VDC
OUTPUT 2: RED+ 18-55VDC
INTC: BLK-
INTL: WH-
NC: GRN-
PC: PNK- 1.0A
CS: -

USB Programmable:

- ◆ Output current
- ◆ Colour temperature range
- ◆ OTP point, Luminous decay compensation, LED thermal protection(NTC)
- ◆ Over load protection point
- ◆ Dimming curve: log/linear
- ◆ Selectable for dimming mode: solo dimming,warm dimming,tunable white,dual dimming,DT8 dimming.

Model List

Model Name	Rated Input Voltage	Max Output Power(Total)	Output Current(Total)	Rated Output Voltage	Efficiency	Dimension
PDL-C1-050D1400U-DALI-PC	120-277VAC	50W max.	2*(140-1400)mA (1mA step)	2*(8-55)VDC	89%	280*30*21.5 mm 11×1.2×0.8 in.

Approvals



Model name code

PDL-C1	=	050D	1400	U	=	DALI	=	PC
①		②	③	④		⑤		⑥

①	Series	PDL Series (DALI DT8)
②	Output power	Maximum output power: 50W
③	Output Current(max)	Output current:1400mA
④	Input voltage	120-277VAC
⑤	Dimming Control	DALI-2 DT8
⑥	Programmable	USB-PC

Specification:

Parameters	Symbols	Test Conditions / Comment	Min	Typ	Max	Units							
INPUT													
Input Voltage	V_{IN}		108		305	V_{AC}							
Rated Input Voltage	$V_{IN(RATED)}$		120		277	V_{AC}							
Input Frequency	f_{line}		47	50/60	63	Hz							
Input Current	I_{IN}	Full Load, $V_{IN} = 120V_{AC}$			0.55	A							
Inrush Current	I_{INRUSH}	Cold Start, $V_{IN} = 277V_{AC}$			60	A							
Leakage Current	$I_{Leakage}$	$V_{IN} = 277V_{AC}$ 60Hz			0.75	mA							
Number of Drivers per MCB(Circuit Breaker)	MCB type	B10	C10	D10	B13	C13	D13	B16	C16	D16	B20	C20	D20
	120V _{AC}	13	15	17	17	19	22	21	24	28	26	30	35
	277V _{AC}	11	18	37	14	24	48	17	29	59	22	37	74

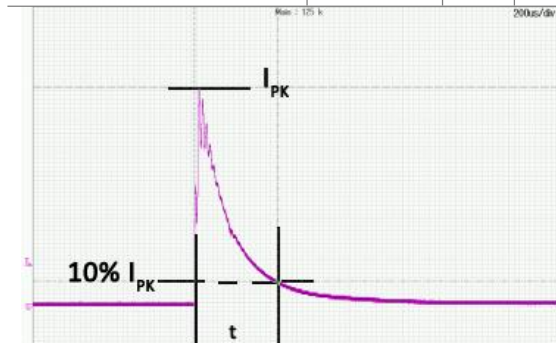

Input Voltage	Inrush Current	t(us)10%-10%
120VAC	15.8A	158
277VAC	42.1A	166
347VAC	NA	NA

General Characteristics

Power Factor	PF	20-100% load, $V_{IN} = 120V_{AC}$	0.9		PF
		40-100% load, $V_{IN} = 277V_{AC}$	0.9		
Total Harmonic Distortion	THD	20-100% load, $V_{IN} = 120V_{AC}$		20	%
		40-100% load, $V_{IN} = 277V_{AC}$		20	
Efficiency	η	Full load, $V_{IN}=120V_{AC}$, $I_{OUT}=1000mA$, $V_{OUT}=50V$, Steady state	87	88	%
		Full load, $V_{IN}=277V_{AC}$, $I_{OUT}=1000mA$, $V_{OUT}=50V$, Steady state	88	89	%
Turn On Delay Time	T_{on_delay}	Cold Start, 400-1400mA		0.8	S
		Cold Start, 140-399mA		1.2	S

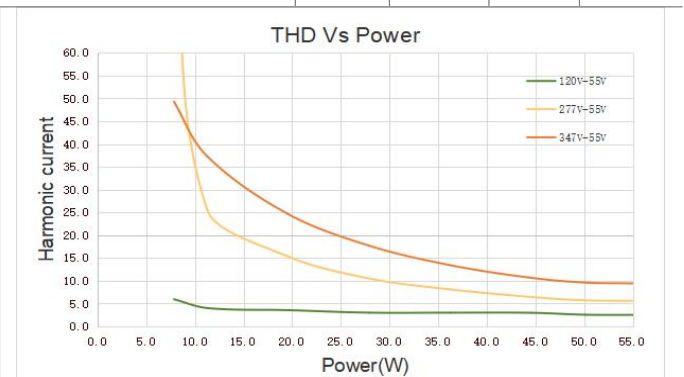
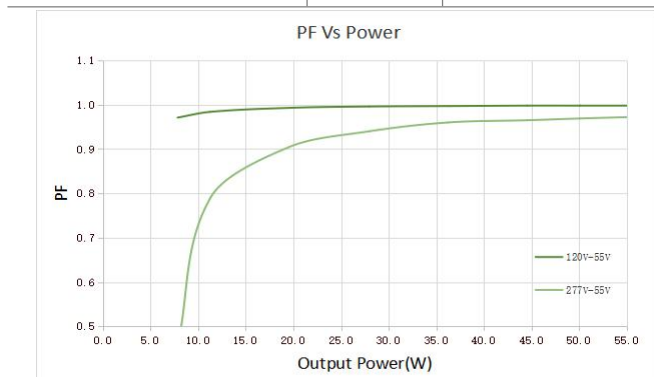

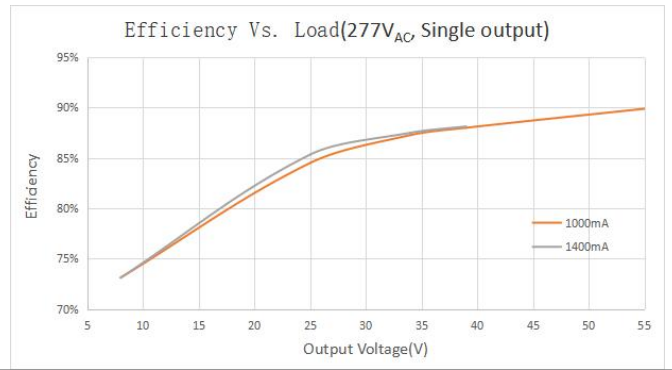
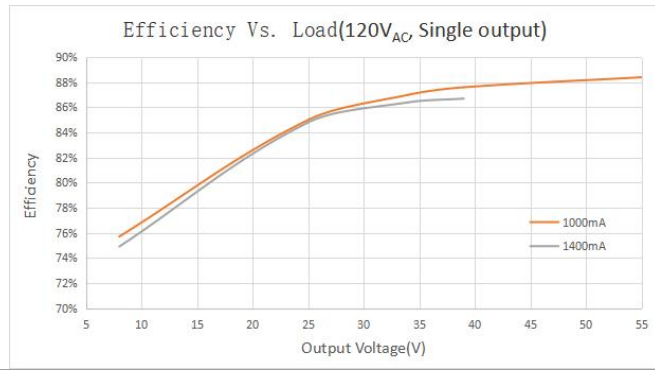

OUTPUT

Programmable Current	Output	I_{OUT}	One Channel	140		1400	mA
Number of Output		N	Independent		2		
Output current tolerance		t	$I_{OUT}=400-1400mA$			5	%
			$I_{OUT}=140-399mA$			7	%
Output Current Range		I_{OUT}	Amplitude Control.	1.4		1400	mA
Output Voltage		V_{OUT}		8		55	V
Output Power		P_{OUT}	See "Operating window"			50	W
Line Regulation		$V_{OUT-LINE}$				1	%
Load Regulation		$I_{OUT-LOAD}$	V_{OUT} from MIN. to MAX.			5	%
Ripple Current		$I_{OUT-RIPPLE}$	Full Load, $(I_{omax}-I_{omin})/(I_{omax}+I_{omin})$			10	%
Output Current Overshoot		$I_{OVERSHOOT}$	Turning Power ON			10	%

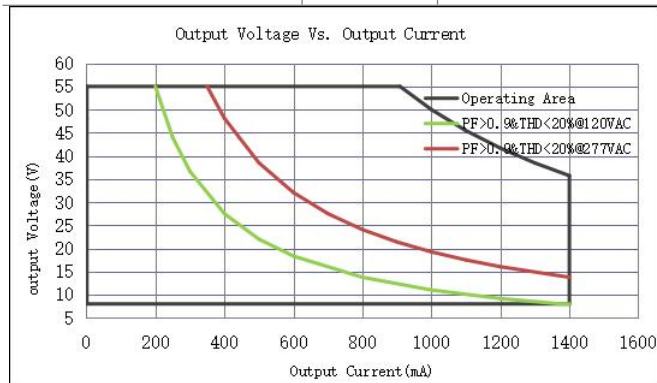

Programming

The driver can be programmed through USB.

- Output current
- Colour temperature range
- OTP point, Luminous decay compensation, LED thermal protection(NTC)
- Over load protection point
- Dimming Curve: Log/linear
- Selectable for dimming mode: solo dimming,warm dimming,Tunable white,Dual Dimming,DT8 Dimming.

USB port	Programming	"LUMIGEAR Programming Tool"
----------	-------------	-----------------------------

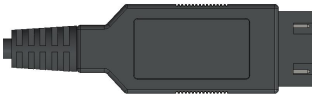
	software				
	Programming tool	“Lumigear tool box”			
	Operating voltage		3.3	3.6	V
	+3.3V Aux power			10	mA
Programming Interface	PGT-USB-TPAC-A				
Programming Cables	PGT-USB-P254				

DALI (L Style)

It complies with the IEC62386-101:2018 Ed2.0, IEC62386-102:2018 Ed2.0, and IEC62386-207 Ed1.0 standard protocols, and can control the driver's on, off, dimming, scene, group, addressing and other functions through standard DALI instructions.

It can be controlled by a DALI Master to perform functions such as turning on/off, dimming, adjusting color temperature, scene selection, grouping, address settings, and more.

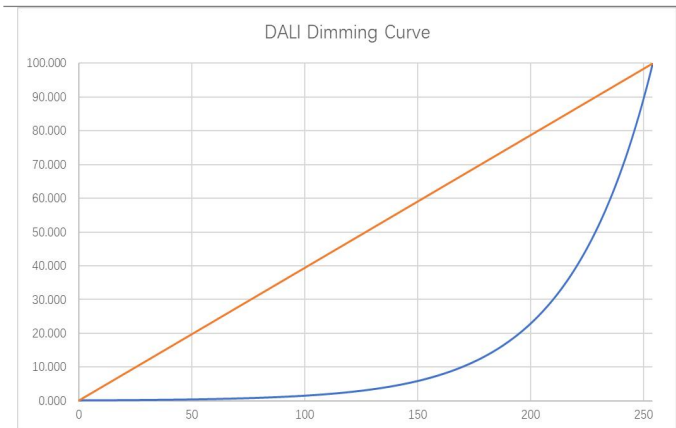

LED Thermal Protection (NTC) Characteristic

The LED thermal protection feature of the driver helps reduce the temperature of the LED module by reducing dual output current together in case of abnormal temperature conditions.

In the end application, care must be taken to place the NTC thermistor close to the hottest spot on the LED module.

If LED thermal protection is not required the NTC port on the LED power supply connector can be left open.

Graphs for reference. The derating limits can be programmed using the Light Touch.

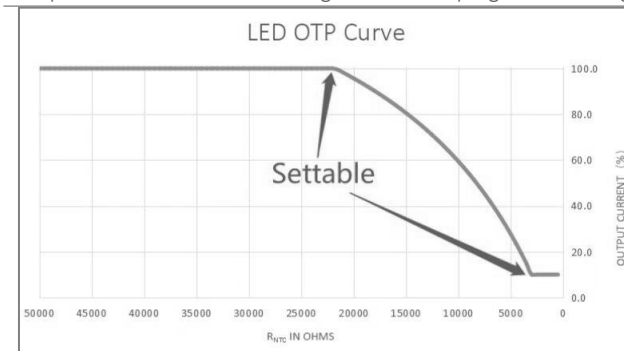

Protection

Over Voltage Protection	V _{OVP}	Recover automatically after fault conditions is removed.			60	V
-------------------------	------------------	--	--	--	----	---

Over load Protection	P_{OLP}	Programmable. The output current will decrease when output power reach P_{OLP}	20		50	W
OLP tolerance	t_{OLP}		100		110	%
Over Temp. Protection	T_{OTP}	Programmable. Current foldback at hotspot greater than T_{OTP}		90		°C
Short Circuit Protection	Recover automatically after fault conditions is removed.					

Environment

Storage Temperature	$T_{Storage}$	Humidity: 5% RH to 95% RH	-40	-	+85	°C
Ambient Operating Temperature	T_a		-30	-	+50	°C
Max. Case Temperature	T_c	Hot spot on case			90	°C
Operating Relative Humidity	H_a	Non-Condensing	10		90	%
Acoustic Noise		Measured from 1 m .			24	dB(A)
Cooling	Convection Cooling					
IP Rating	Dry and damp UL approved					

Others

Life Time	T_{Life}	Full Load, 80°C case temperature, $V_{IN} = 120/277V_{AC}$	50			kHrs
MTBF	T_{MTBF}	Full Load, 25°C ambient temperature $V_{IN} = 120/277V_{AC}$	200			kHrs
Net Weight	W_{NET}			280		g
Warranty	5 Years Warranty at $T_c \leq 80^\circ C$					
Flicker	IEEE 1789					

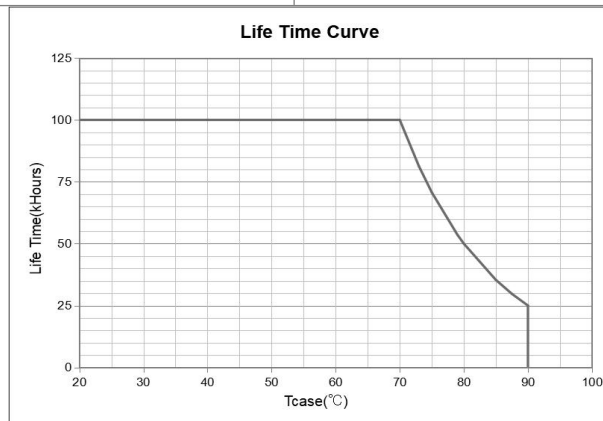

Safety Compliance

CUL/UL	UL8750, CAN/CSA-C22.2 No. 250.13
--------	----------------------------------

Electromagnetic Compliance

EMC Requirements	Standard	Conditions
EMI Emissions	FCC Title 47 Part 15B	Class B at 120V _{AC} , Class A at 277V _{AC}
Voltage Fluctuations and Flicker	IEC61000-3-3	
Immunity Compliance	IEC 61000-4-2	±8kV air Discharge, ±6kV Contact Discharge
	ANSI C62.41	± 2kV Common and Differential Mode, test at 2 Ω, 5 strikes/1minute interval (40 total strikes)

ANSI C62.41.1	2.5kV Ring Wave, test at 30 Ω 7 Strikes/1 minute interval, Common and Differential mode, 56 total strikes
IEC 61000-4-11	>95% dip, .5 period; 30% dip, 25 periods; 95% reduction, 250 periods
IEC 61000-4-4	± 2kV Direct couple to Line input, 5kHz repetition rate, 15mS duration, 300mS period. 7 coupling paths, 1 minute per path (14 total combinations)

Note: Unless otherwise specified, all the above parameters are measured at ambient temperature of 25°C and rated voltage.

Typical Application:

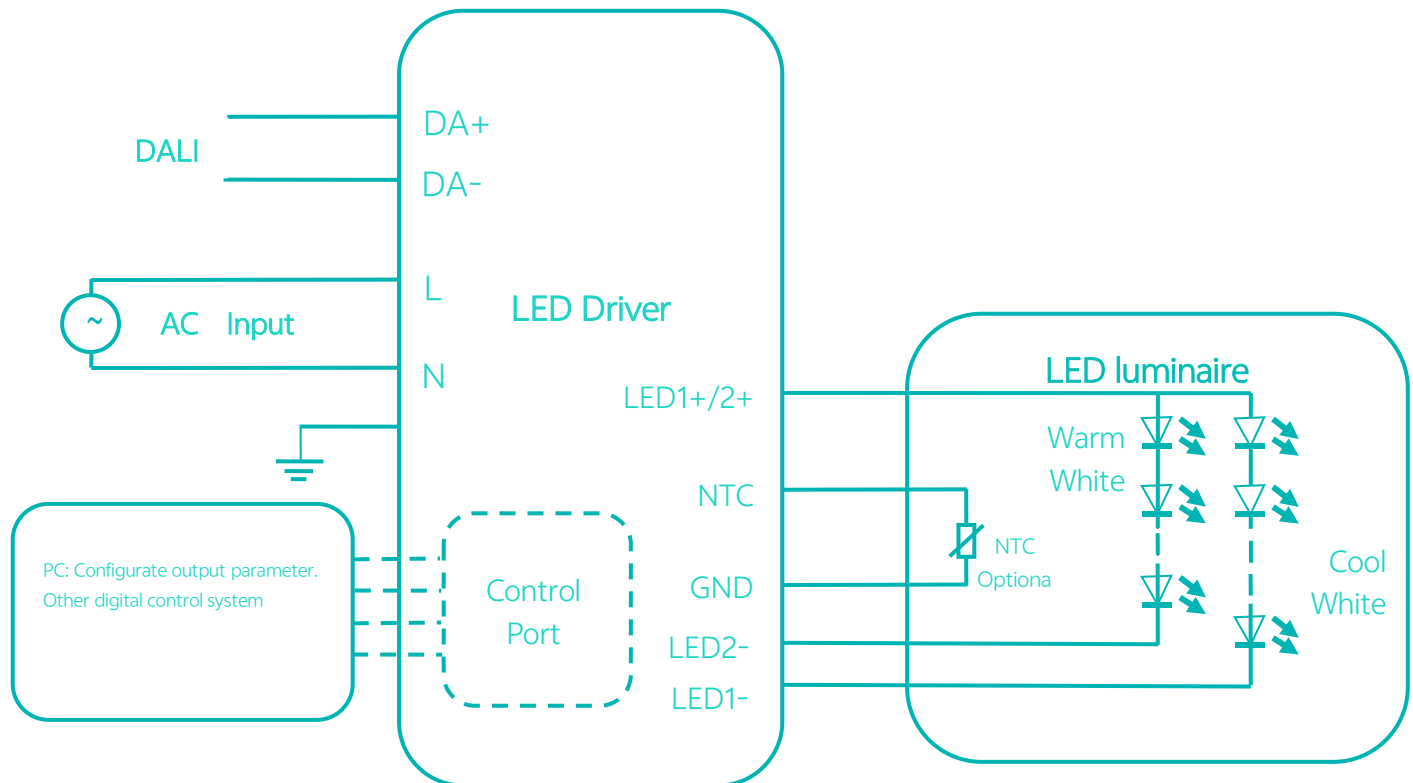

Packaging

Driver quantity (pcs)	Layer	Weight (kg)	Outer dimensions of Carton L*W*H(mm)
63	7	15	330 X 305 X 240

Mechanical Drawing:

