

## Features & Benefits

- Universal ac input voltage(120-277VAC)
- Brick form factor, metal sheet case(white)
- Triac dimming + isolated 0-10v dimming ,dim down to true 1%
- Suitable for indoor use
- Flicker free, excellent camera compatibility
- UL Class2, Class P
- Comply with IEEE1789, UL8750

### Programmable feature:

- ◆ Output current, dim to off, min dimming level
- ◆ Log/linear/square dim curves
- ◆ OTP point of driver, led thermal protection, luminous decay compensation
- ◆ Output voltage of aux power
- ◆ Over load protection point
- ◆ End-of-life indicator, fade in time

## Model List

Model Name	Rated Input Voltage	Max Output Power(Total)	Output Current(Total)	Rated Output Voltage	Efficiency	Dimension
PDC-A1-025S0700U-VT-AUX-PC-A-M	120-277VAC	25W max.	70-700mA	10-55VDC	87%	127*60.3*27.5 mm 4.9*2.3*1.1 in.

## Optional Function

- Aux power: 12-24V programmable,1W
- Built-in 3 current adjustment by INT switch
- Built-in 3/4/5CCT switch
- Mounting feet or stud type
- Digital and analog interface ready

## Approvals

TRIAC 0/1-10 V  CLASS P

## Model name code

<u>PDC-A1</u>	-	<u>025S</u>	<u>0700</u>	<u>U</u>	-	<u>VT</u>	-	<u>AUX</u>	-	<u>PC</u>	-	<u>A</u>	-	<u>M</u>
①		②	③	④		⑤		⑥		⑦		⑧		⑨

①	Series	PDC Series
②	Output power	Maximum output power: 25W
③	Output current(max)	Maximum output current: 700mA
④	Input voltage	120-277VAC

⑤	Dimming Control	Triac&0-10V
⑥	AUX	AUX: with Auxiliary source BLANK:without Auxiliary source
⑦	Programmable	USB-PC
⑧	Switch function	A: without INT and CCT Switch    B:with INT Switch only C: with CCT Switch only            D :with INT+CCT Switch.
⑨	Installation	M: Mounting feet BLANK:Stud type

## Specification:

Parameters	Symbols	Test Conditions / Comment	Min	Typ	Max	Units							
<b>INPUT</b>													
Input Voltage	$V_{IN}$		108		305	$V_{AC}$							
Rated Input Voltage	$V_{IN\,RATED}$		120		277	$V_{AC}$							
	$V_{IN\,RATED\,TRIAC}$	Phase Cut Dimming		120		$V_{AC}$							
Input Frequency	$f_{line}$		47	50/60	63	Hz							
Input Current	$I_{IN}$	Full Load, $V_{IN} = 120V_{AC}$			0.28	A							
Inrush Current	$I_{INRUSH}$	Cold Start, $V_{IN} = 277V_{AC}$			30	A							
Leakage Current	$I_{Leakage}$	$V_{IN} = 277V_{AC}$ 60Hz			0.75	mA							
Number of Drivers per MCB(Circuit Breaker)	MCB type	B10	C10	D10	B13	C13	D13	B16	C16	D16	B20	C20	D20
	120V <sub>AC</sub>	12	17	19	15	22	25	19	27	31	24	34	39
	277V <sub>AC</sub>	7	11	23	9	15	30	11	18	37	14	23	47

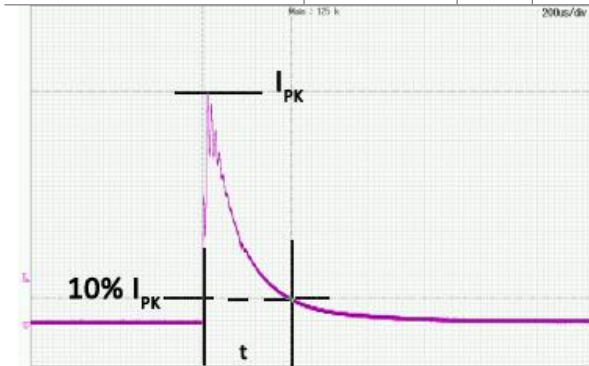

Input Voltage	Inrush Current	t(us)10%-10%
120VAC	16.1A	192
277VAC	28.0A	216
347VAC	NA	NA

## General Characteristics

Power Factor	PF	20-100% load, $V_{IN} = 120V_{AC}$	0.9		PF
		40-100% load, $V_{IN} = 277V_{AC}$	0.9		
Total Harmonic Distortion	THD	20-100% load, $V_{IN} = 120V_{AC}$		20	%
		40-100% load, $V_{IN} = 277V_{AC}$		20	%
Turn On Delay Time	$T_{on\_delay}$	Cold Start, 500-1200mA		0.5	S
		Cold Start, 120-499mA		0.75	S
Efficiency	$\eta$	Full load, $V_{IN} = 120V_{AC}$ , $I_{OUT} = 490mA$ , Steady state	85	87	%
		Full load, $V_{IN} = 277V_{AC}$ , $I_{OUT} = 490mA$ , Steady state	85	87	%

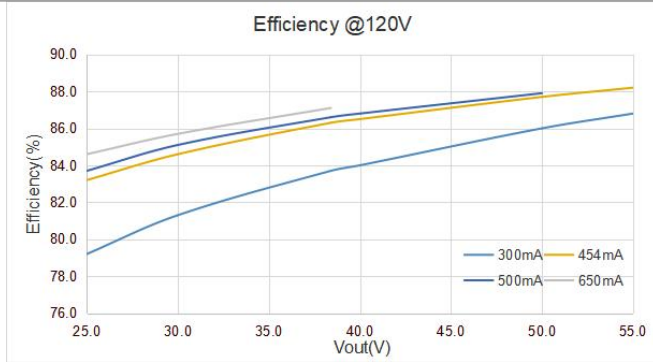
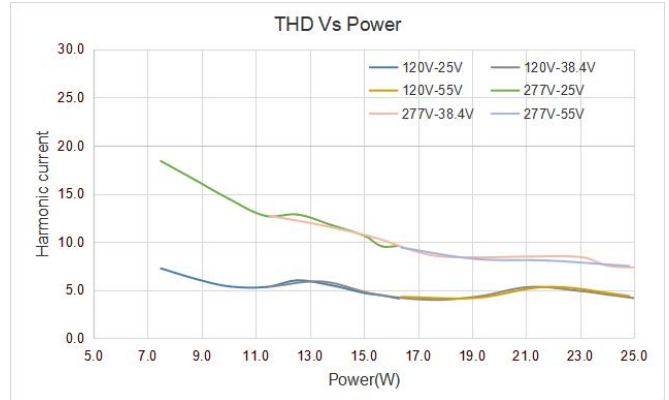
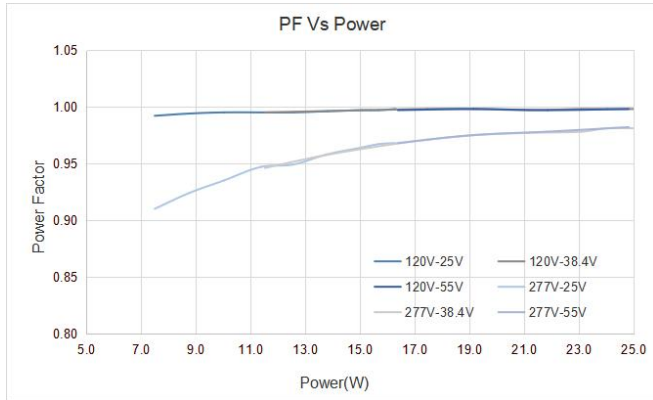

## OUTPUT

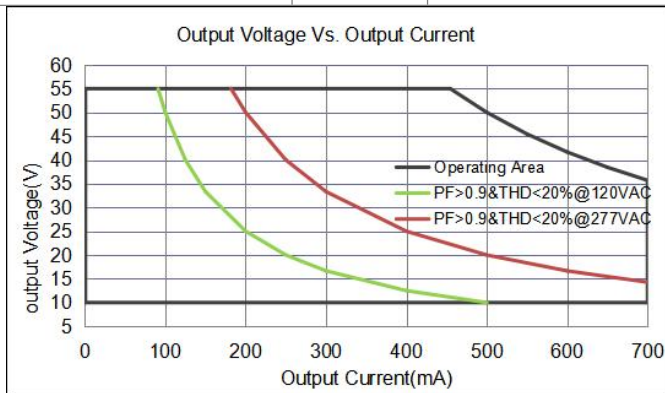

Programmable Output Current	$I_{OUT-PRG}$		70		700	mA
Output Current Tolerance	t	$I_{OUT}=300-700mA$	-5		+5	%
Default Output Current	$I_{OUT}$			700		mA
Output Current Range	$I_{OUT}$	Amplitude Control.	0.7		700	mA
Output Voltage	$V_{OUT}$		10		55	V
Output Power	$P_{OUT}$	See "Operating window"			25	W
Line Regulation	$V_{OUT-LINE}$				1	%
Load Regulation	$I_{OUT-LOAD}$	$V_{OUT}$ from MIN. to MAX.			5	%
Ripple Current	$I_{OUT-RIPPLE}$	Full Load, $(I_{omax}-I_{omin})/(I_{omax}+I_{omin})$			10	%
Output Current Overshoot	$I_{OVERSHOOT}$	Turning Power ON			10	%



## Programming

The driver can be programmed through RJ9.

NO.	Item	Default setting
1	Output current(1mA step)	See “output ”section
2	Dim to off, Min Dimming Level	See “0~10V or Resistor Dimming” section
3	Output voltage of aux power	See “Auxiliary source” section
4	OTP point of driver	See” OTP protection” section
5	LED thermal protection	Disable
6	Luminous decay compensation	Disable
7	End-of-life indicator	Disable
8	Fade in time	Disable
9	Over load protection point	See” OLP protection” section
10	Dimming curve: Log/linear/square dim curves	See “0~10V or Resistor Dimming” section

RJ9	Programming software	“LUMIGEAR Programming Tool”				
	Programming tool	“Lumigear tool box”				
	Operating voltage			5	5.5	V
	Pull up resistor	RX is pulled up to +5V			15K	Ohm
		TX is pulled up to +5V			62K	Ohm
+5V Aux power				10	mA	
Programming Interface	PGT-USB-TPAC-A					
Programming Cables	PGT-USB-RJ9					

## 0~10V Dimming

The 0~10V or resistor dimming can be used to dim the output current via a standard commercial wall dimmer (0~10V<sub>DC</sub>) or an external control voltage source (0~10V<sub>DC</sub>) or external resistor.

Dimming Curve	Linear. please see “Dimming curve”.				
Absolute Maximum Voltage on 0~10V Pin	V <sub>DIM</sub>		0	300	V <sub>AC</sub>
Source Current on 0~10V Dimming Pin	I <sub>DIM</sub>		200		uA
Light On	V <sub>DIM-on</sub>	Programmable		0.9	V
Light Off	V <sub>DIM-off</sub>	Programmable		0.7	V
Dimming Voltage for Full Bright	V <sub>DIM-MAX</sub>	Programmable		8	V
Standby power	P <sub>STANDBY</sub>	Light Off		0.7	W

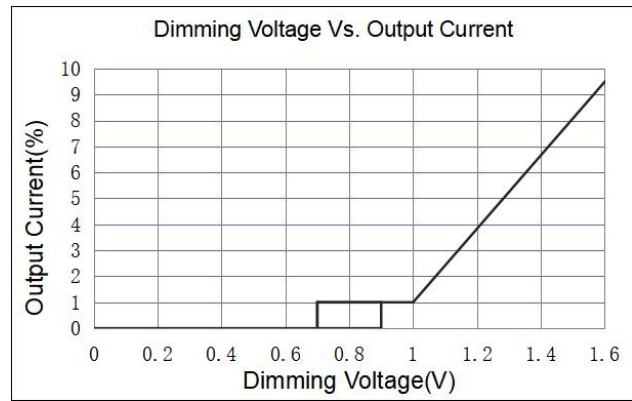
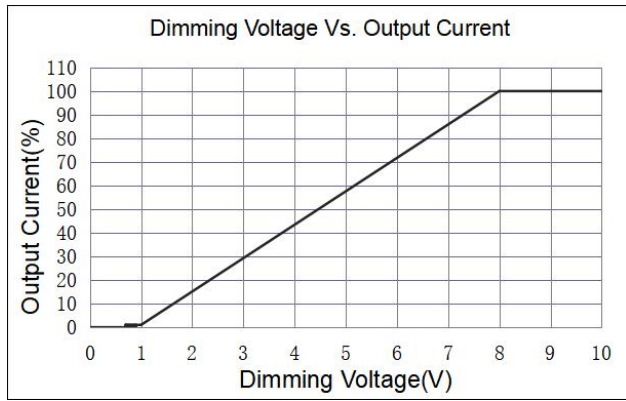

## Triac Dimming

The unit is compatible With Leading-edge and Trailing-edge Dimmer.

Input Voltage	$V_{IN-TRIAC DIM}$		120	$V_{AC}$
Suggest Load Range	$P_{Suggest}$	$V_{IN} = 120 V_{AC}$	40	100 %

Compatible Phase Cut Dimmers

No.	Mfg.	Model	Remark	No.	Mfg.	Model	Remark
1	Lutron	MACL-153M		11	Leviton	1B34L1	
2	Lutron	LGCL-153PL		12	Leviton	IPL06	
3	Lutron	GLU12-F23622		13	Leviton	SureSlide 6633	
4	Leviton	111506		14	Leviton	IPE04	
5	Lutron	GLV-600		15	Leviton	IPL06-102	
6	Lutron	DVLV-600P		16	Lutron	DVCL-153P	
7	Lutron	MALV-600		17	Legrand	LSLV603	
8	Lutron	NT-1000		18	Legrand	RHCL453P	
9	Lutron	SLV-600P		19	Lutron	1K35O2	
10	Lutron	MA-600		20	Lutron	DV-600P	

## INT(Output current) selection(Optional)

The output current can be set by the INT selection switch

Built-in INT selection switch	Programmable, Selectable 3 positions, Please contact Lumigear for details
-------------------------------	---

## CCT selection(Optional)

Build in CCT selection switch	Settable, 3/4/5CCT , Please contact Lumigear for details
-------------------------------	--

## Auxiliary source(Optional)

Max.power	$P_{AUX}$			1	W
Voltage range	$V_{AUX}$	Programmable	12	24	Vdc
	$V_{AUX\_DEFAULT}$	Default voltage		12	Vdc

Voltage tolerance	$t_{AUX}$				8	%
Over load Protection	$P_{OLP,AUX}$	Foldback mode			1.5	W

## Protection

Over Voltage Protection	$V_{OVP}$	The unit will recover automatically after fault conditions is removed.		60		V
Over load protection	$P_{OLP}$	Programmable. The output current will decrease when output power reach $P_{OLP}$	10		25	W
OLP tolerance	$t_{OLP}$		100		110	%
Over Temp. Protection	$T_{OTP}$	Current foldback at hotspot greater than $T_{OTP}$		90		°C
Short Circuit Protection	The unit will recover automatically after fault conditions is removed.					

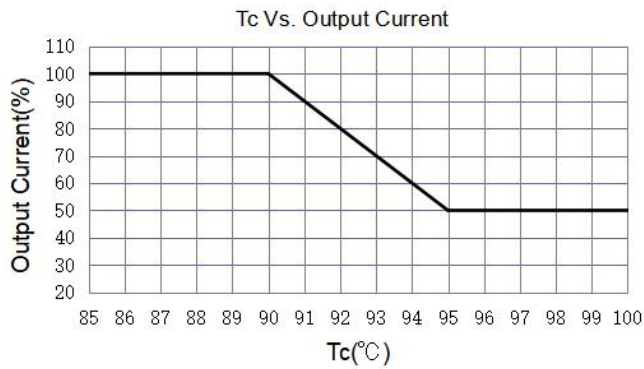

## Environment

Storage Temperature	$T_{Storage}$	Humidity: 5% RH to 95% RH	-40	-	+85	°C
Ambient Operating Temperature	$T_a$		-30	-	+50	°C
Max. Case Temperature	$T_c$	Hot spot on case			90	°C
Operating Relative Humidity	$H_a$	Non-Condensing	10		90	%
Acoustic Noise		<One feet, under and dimming level for both 0-10V and triac.			22	db
Cooling	Convection Cooling					
IP Rating	Dry and damp UL approved					

## Others

Life Time	$T_{Life}$	Full Load, 85°C case temperature,	50			kHrs
MTBF	$T_{MTBF}$	Full Load, 25°C ambient temperature	200			kHrs
Net Weight	$W_{NET}$			235		g
Warranty	5 Years Warranty at $T_c \leq 85^\circ\text{C}$					
Flicker	Meet JA8					

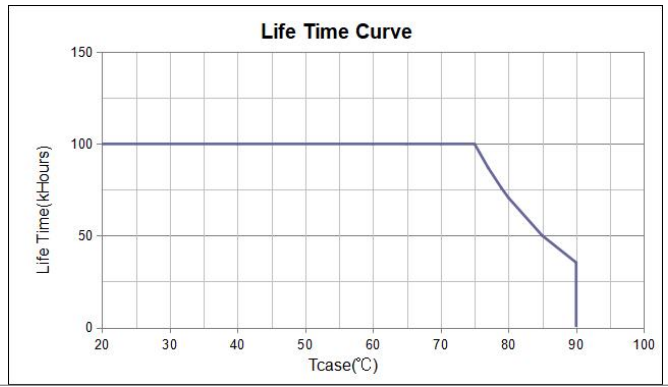

## Safety Compliance

CUL/UL	UL8750, CAN/CSA-C22.2 No. 250.13
LVD	EN61347

## Electromagnetic Compliance

EMC Requirements	Standard	Conditions
EMI Emissions	FCC Title 47 Part 15	Class B at 120V <sub>AC</sub> , Class A at 277V <sub>AC</sub>
Voltage Fluctuations and Flicker	IEC61000-3-3	
Immunity Compliance	IEC 61000-4-2	±8kV air Discharge, ±6kV Contact Discharge
	ANSI/IEEE C62.41-2002	± 2kV Common and Differential Mode, test at 2 Ω, 5 strikes/1minute interval (40 total strikes)
	ANSI/IEEE C62.41.1-2002	2.5kV Ring Wave, test at 30Ω 7 Strikes/1 minute interval, Common and Differential mode, 56 total strikes
	IEC 61000-4-11	>95% dip, .5 period; 30% dip, 25 periods; 95% reduction, 250 periods
	IEC 61000-4-4	± 2kV Direct couple to Line input, 5kHz repetition rate, 15mS duration, 300mS period. 7 coupling paths, 1 minute per path (14 total combinations)

Note: Unless otherwise specified, all the above parameters are measured at ambient temperature of 25°C and rated voltage.

## Typical Application

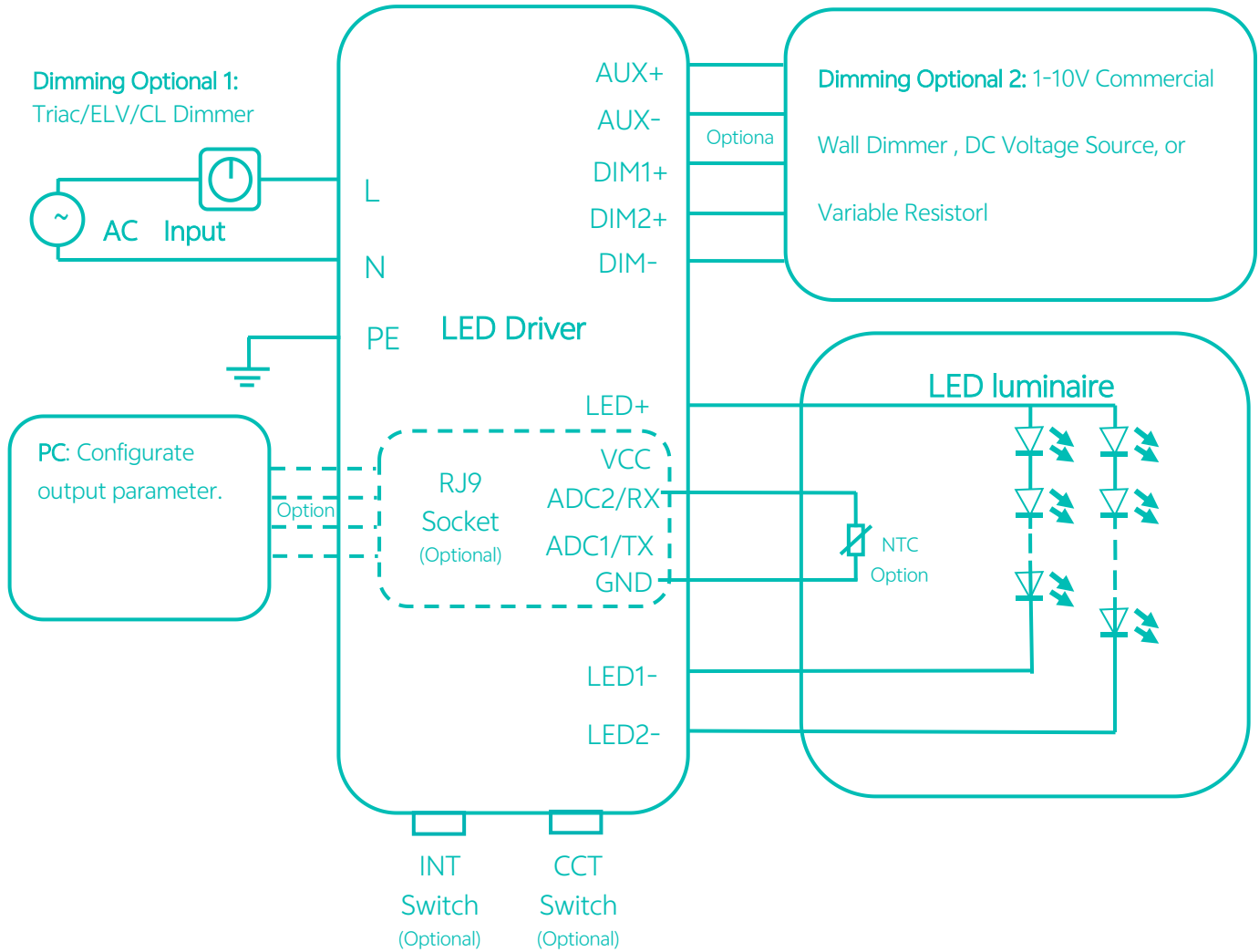

## Packaging

Driver quantity (pcs)	Layer	Weight (kg)	Outer dimensions of Carton L*W*H(mm)
48	6	13	L350*W325*H240

## Mechanical Drawing:

S TYPE:

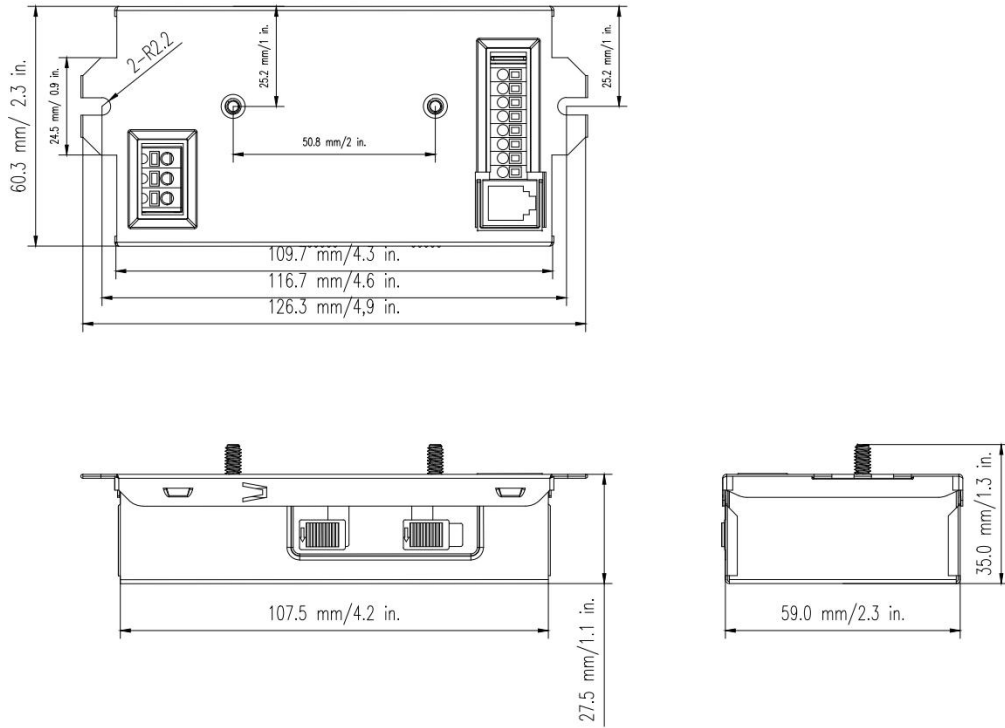

M TYPE:

