

Features & Benefits

- Universal AC input voltage(120-277VAC)
- Linear form factor, metal sheet case(white), side feed
- Isolated 0-10v dimming interface, dim down to true 2.3 mA
- Low standby power: <0.7W@120VAC
- Suitable for indoor use
- Flicker free, excellent camera compatibility, spec-grade smoothness
- Class2, Class P
- Comply with IEEE1789, UL8750

USB programmable feature:

- ◆ Output current, dim to off, min dimming level
- ◆ Otp point of driver, led module thermal protection, luminous decay compensation,
- ◆ End-of-life indicator, fade in time, over load protection point
- ◆ Dimming curve: Log/linear/square dim curves



Model List

Model Name	Rated Input Voltage	Max Output Power(Total)	Output Current(Total)	Rated Output Voltage	Efficiency	Dimension
ESL-A1-085S2300U-V-AUX-PC-2	120-277VAC	85W max.	230-2300mA	10-55VDC	90%	380*30*25.4 mm 14.9*1.2*1 in.

Optional Function

Aux power: 12-24V programmable,1W

Approvals



Model name code

ESL-A1	-	085S	2300	U	-	V	-	AUX	-	PC	-	2
①		②	③	④		⑤		⑥		⑦		⑧

①	Series	ESL Series
②	Output power	Maximum output power: 85W
③	Output current(max)	Maximum output current: 2300mA
④	Input voltage	U=120-277VAC M=120-347VAC
⑤	Dimming Control	0-10V
⑥	AUX	AUX: with Auxiliary source BLANK:without Auxiliary source
⑦	Programmable	USB-PC
⑧	Surge protection level	2-10 2=2kV 10=10kV

Specification:

Parameters	Symbols	Test Conditions / Comment	Min	Typ	Max	Units							
INPUT													
Input Voltage	V_{IN}		108		305	V_{AC}							
Rated Input Voltage	$V_{INRATED}$		120		277	V_{AC}							
Input Frequency	f_{line}		47	50/60	63	Hz							
Input Current	I_{IN}	Full Load, $V_{IN} = 120V_{AC}$			0.94	A							
Inrush Current	I_{INRUSH}	Cold Start, $V_{IN} = 277V_{AC}$			60	A							
Leakage Current	$I_{Leakage}$	$V_{IN} = 277V_{AC}$, 60Hz			0.75	mA							
Number of Drivers per MCB(Circuit Breaker)	MCB type	B10	C10	D10	B13	C13	D13	B16	C16	D16	B20	C20	D20
	120V _{AC}	13	15	17	17	20	22	21	24	28	26	30	35
	277V _{AC}	9	15	31	39	20	40	15	25	50	18	31	62

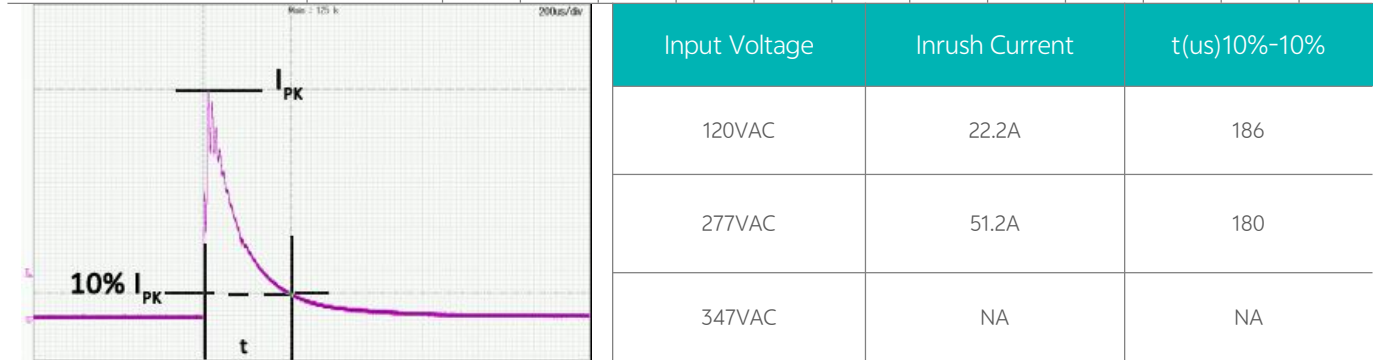

General Characteristics

Power Factor	PF	20-100% load, $V_{IN} = 120V_{AC}$	0.9		PF
		40-100% load, $V_{IN} = 277V_{AC}$	0.9		
Total Harmonic Distortion	THD	20-100% load, $V_{IN} = 120V_{AC}$		20	%
		40-100% load, $V_{IN} = 277V_{AC}$		20	%
Efficiency	η	$I_{OUT}=1600mA$, $V_{OUT}=55V$, $V_{IN} = 120V_{AC}$, steady state	87	88	%
		$I_{OUT}=1600mA$, $V_{OUT}=55V$, $V_{IN} = 277V_{AC}$, steady state	89	90	%
Turn On Delay Time	T_{on_delay}	Cold Start, 700-2300mA		0.5	S
		Cold Start, 230-699mA		1	S

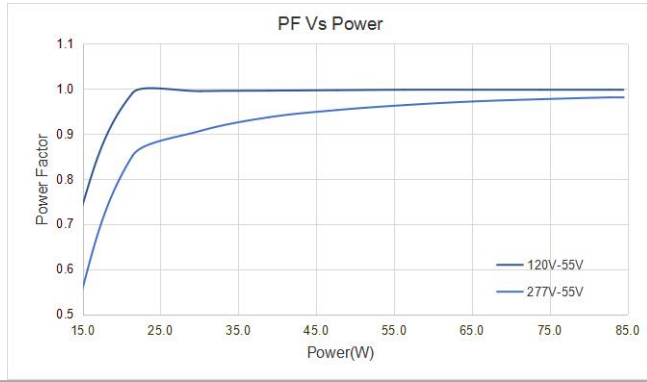

OUTPUT

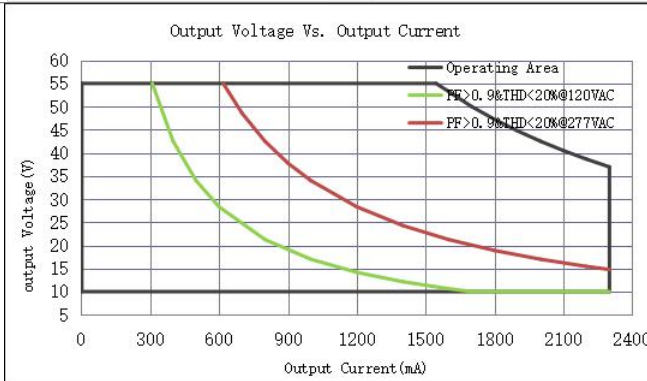

Programmable Current	Output	I_{OUT}		230		2300	mA
Output current tolerance	t		$I_{OUT}=700-2300mA$			5	%
			$I_{OUT}=230-699mA$			7	%
Output Current Range		I_{OUT}	Amplitude Control.	2.3		2300	mA
Output Voltage		V_{OUT}		10		55	V
Output Power		P_{OUT}	See "Operating window"			85	W
Line Regulation		$V_{OUT-LINE}$				1	%
Load Regulation		$I_{OUT-LOAD}$	V_{OUT} from MIN. to MAX.			5	%
Ripple Current		$I_{OUT-RIPPLE}$	Full Load, $(I_{omax}-I_{omin})/(I_{omax}+I_{omin})$			10	%
Output Current Overshoot		$I_{OVERSHOOT}$	Turning Power ON			10	%



Programming

The driver can be programmed through USB.

- Output current(1mA step)
- Dim to off, Min Dimming Level
- Output voltage of aux power
- OTP point of driver
- LED thermal protection
- Luminous decay compensation
- End-of-life indicator
- Fade in time
- Over load protection point
- Log/linear/square dim curves

USB port	The USB port can recognize the type of input signal, analog or digital. So the driver can be easily connected to a digital control system, or can be connected to an external NTC / rheostat / current selection switch to set the driver(eg: output current , dimming level, and so on).				
	Programming software	"LUMIGEAR Programming Tool"			
	Programming tool	"Lumigear tool box"			
	Operating voltage		3.3	3.6	V
	Pull up resistor	TX is pulled up to +3.3V	62K		Ohm
RX is pulled up to +3.3V		15K		Ohm	
Programming Interface	PGT-USB-TPAC-A				
Programming Cables	PGT-USB-P254				

0~10V or Resistor Dimming

The 0~10V or resistor dimming can be used to dim the output Current via a standard commercial wall dimmer (0~10V_{DC}) or an external control voltage source (0~10V_{DC}) or external resistor.

Dimming Curve	Linear. please see "Dimming curve".				
Dimming Mode					
Absolute Maximum Voltage on 0~10V Pin	V _{DIM}		0	50	V
Source Current on 0~10V Dimming Pin	I _{DIM}		200	500	uA
Light On	V _{DIM-on}	Programmable		0.9	V
Light Off	V _{DIM-off}	Programmable		0.7	V
Clamp Voltage at Min dimming level	V _{DIM-Clamp}	Programmable		1	V
Dimming Voltage for Full Bright	V _{DIM-MAX}	Programmable		8	V
Leakage Voltage	V _{Leak_rms}	Voltage between DIM- and Ground		20	V _{AC}
Standby power	P _{STANDBY}	Light Off, V _{IN} =120V		0.6	W

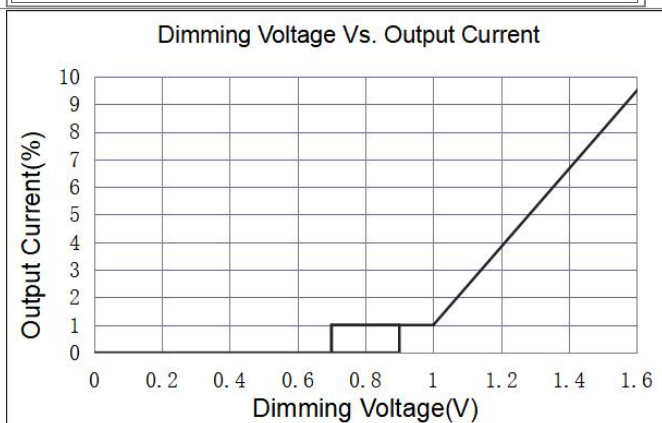
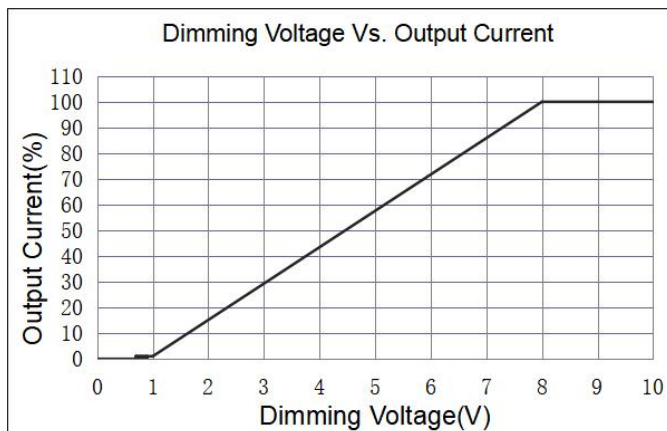
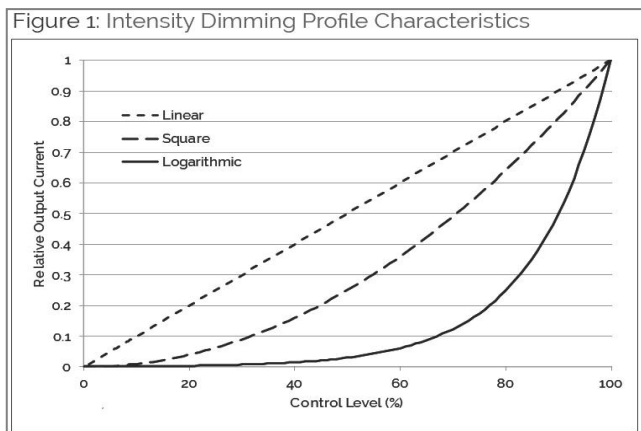

Auxiliary source (Optional)

Max.power	P_{AUX}			1	W
Voltage range	V_{AUX}	Programmable	12	24	Vdc
	$V_{AUX_DEFAULT}$	Default voltage		12	Vdc
Voltage tolerance	t_{AUX}			8	%
Over load Protection	P_{OLP_AUX}	Foldback mode		1.5	W

LED Thermal Protection (NTC) Characteristic

The LED thermal protection feature of the driver helps reduce the temperature of the LED module by reducing dual output current together in case of abnormal temperature conditions.

In the end application, care must be taken to place the NTC thermistor close to the hottest spot on the LED module.

If LED thermal protection is not required the NTC port on the LED power supply connector can be left open.

Graphs for reference. The derating limits can be programmed using the Light Touch.

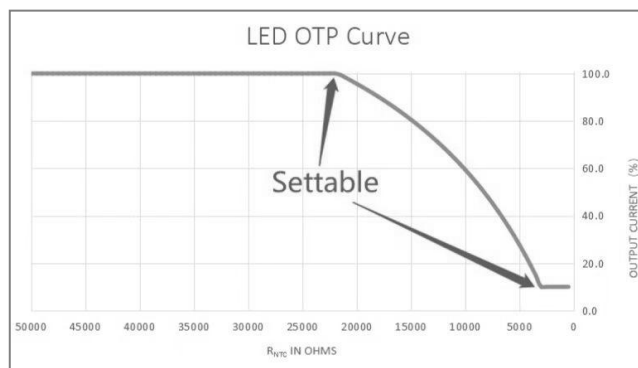

Protection

Over Voltage Protection	V _{OVP}	Recover automatically after fault conditions is removed.			60	V
Over load protection	P _{OLP}	Programmable.The output current will decrease when output power reach P _{OLP}	34		85	W
OLP tolerance	t _{OLP}		100		110	%
Over Temp. Protection	T _{OTP}	Programmable. Current foldback at hotspot greater than T _{OTP}		90		°C
Short Circuit Protection	The unit will recover automatically after fault conditions is removed.					

Environment

Storage Temperature	T _{Storage}	Humidity: 5% RH to 95% RH	-40	-	+85	°C
Ambient Operating Temperature	T _a		-30	-	+55	°C
Max. Case Temperature	T _c	Hot spot on case			90	°C
Operating Relative Humidity	H _a	Non-Condensing	10		90	%
Acoustic Noise		Measured from 1 m w/o dimmer.			24	dBA
Cooling	Convection Cooling					
IP Rating	Dry and damp UL approved					

Others

Life Time	T _{Life}	Full Load, 80°C case temperature, V _{IN} = 120/277V _{AC}	50			kHrs
MTBF	T _{MTBF}	Full Load, 25°C ambient temperature V _{IN} = 120/277V _{AC}	200			kHrs
Net Weight	W _{NET}			375		g
Warranty	5 Years Warranty at T _c ≤80°C					
Flicker	IEEE 1789,Title 24					

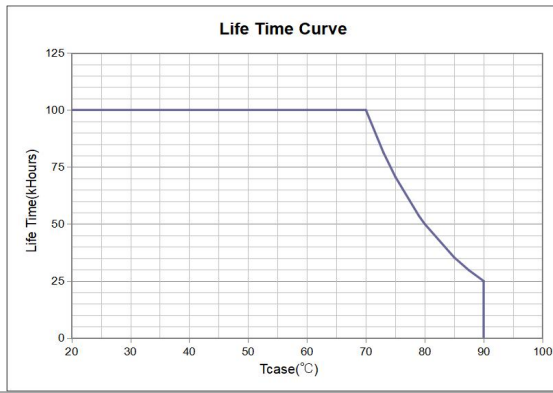

Safety Compliance

CUL/UL	UL8750, CAN/CSA-C22.2 No. 250.13
--------	----------------------------------

Electromagnetic Compliance

EMC Requirements	Standard	Conditions
EMI Emissions	FCC Title 47 Part 15B	Class B at 120V _{AC} , Class A at 277V _{AC}
Voltage Fluctuations and Flicker	IEC61000-3-3	
Immunity Compliance	IEC 61000-4-2	±8kV air Discharge, ±6kV Contact Discharge
	ANSI C82.77-5-2015(Optional)	Category B 6KV
	ANSI C62.41.1	2.5kV Ring Wave, test at 30Ω 7 Strikes/1 minute interval, Common and Differential mode, 56 total strikes
	IEC 61000-4-11	>95% dip, .5 period; 30% dip, 25 periods; 95% reduction, 250 periods
	IEC 61000-4-4	± 2kV Direct couple to Line input, 5kHz repetition rate, 15mS duration, 300mS period. 7 coupling paths, 1 minute per path (14 total combinations)

Note: Unless otherwise specified, all the above parameters are measured at ambient temperature of 25°C and rated voltage.

Typical Application

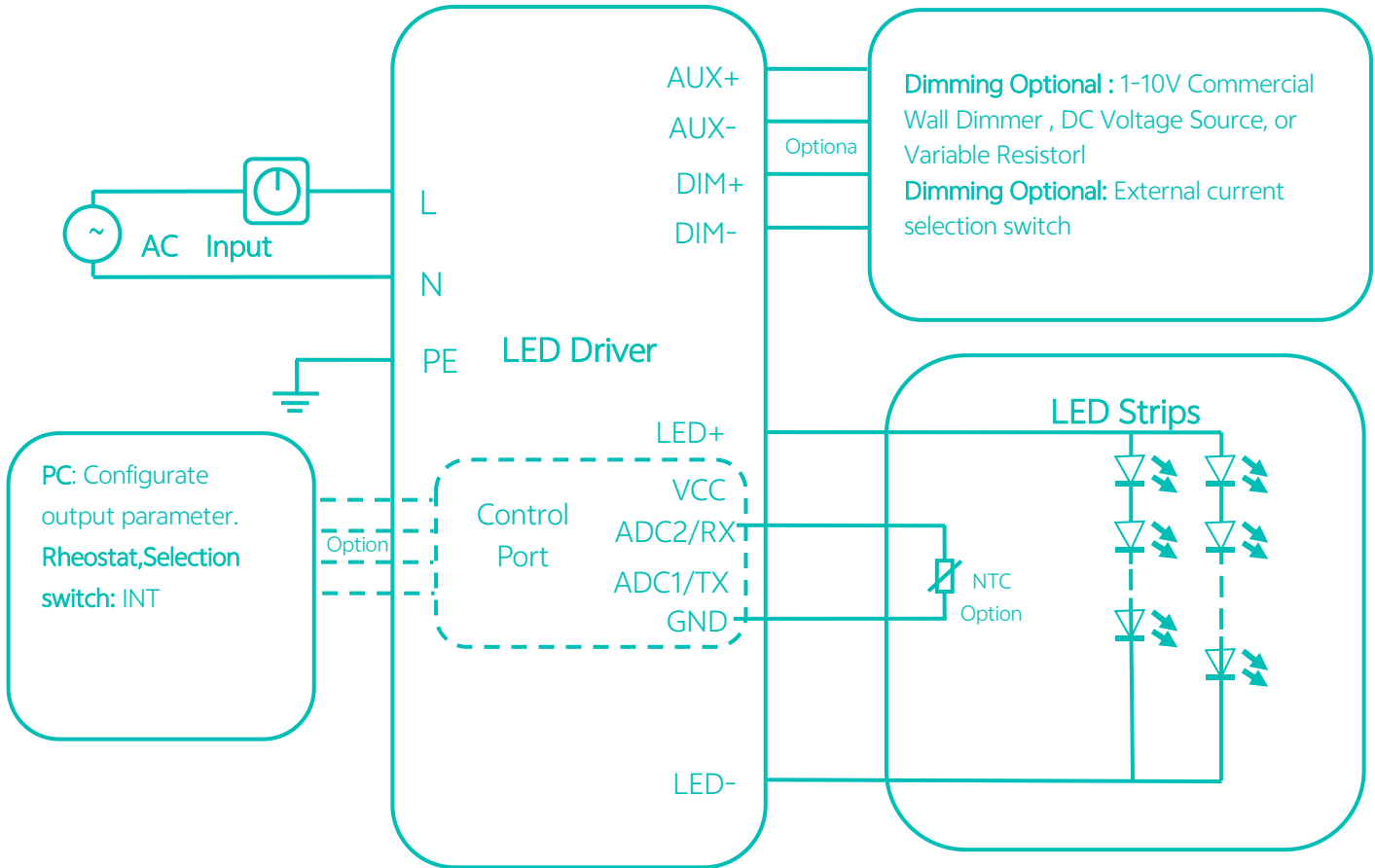

Packaging

Version	Driver quantity (pcs)	Layer	Weight (kg)	Outer dimensions of Carton L*W*H(mm)
Standard Style	35	5	14.5	400 X 275 X 180

Mechanical Drawing:

