

## Features & Benefits

- Universal AC Input voltage(120-277VAC)
- Compact form factor, metal sheet case
- Isolated 0-10v dimming ,dim down to true 1%
- Suitable for indoor use
- Flicker free, excellent camera compatibility
- UL Class2, Class P
- Comply IEEE1789, UL8750
- Operating temperature: -30°C~+50°C

### Programmable feature:

- ◆ Output current, dim to off, min dimming level, output voltage of aux power
- ◆ OTP point of driver, LED thermal protection, luminous decay compensation
- ◆ End-of-life indicator, fade in time, over load protection point

## Model List

Model Name	Rated Input Voltage	Max Output Power(Total)	Output Current(Total)	Rated Output Voltage	Efficiency	Dimension
ESC-B1-055D2000U-V-AUX-PC-A-M	120-277VAC	55W max.	200-2000mA	10-55VDC	89%	127*60.3*27.5 mm 5.0*2.3*1.1 in.

## Optional Function

- Aux power: 12-24V programmable,1W
- Built-in current adjustment by 3INT switch
- Built-in 5CCT switch
- Mounting feet or stud type
- Digital and analog interface ready

## Approvals



### Model name code

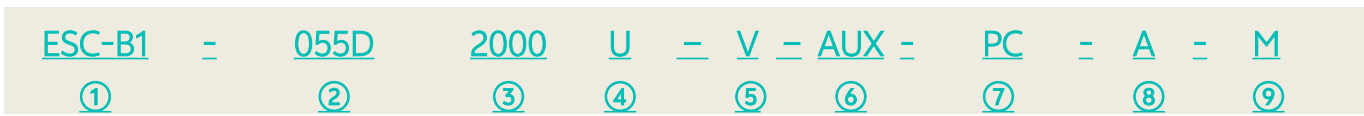

①	Series	Essence Series
②	Output power	Maximum output power: 55W
③	Output current(max)	Maximum output current: 2000mA
④	Input voltage	120-277VAC

⑤	Dimming Control	0-10V
⑥	AUX	AUX: with Auxiliary source BLANK: without Auxiliary source
⑦	Programmable	USB-PC
⑧	Output current and CCT set switch	A: Without INT/CCT switch    B: INT switch only C: CCT switch only            D: INT + CCT switches
⑨	Form Factor	BLANK: Stud+bottom fed M: Mounting feet+side fed

## Specification:

Parameters	Symbols	Test Conditions / Comment	Min	Typ	Max	Units
------------	---------	---------------------------	-----	-----	-----	-------

### INPUT

Input Voltage	$V_{IN}$		108		305	$V_{AC}$
Rated Input Voltage	$V_{IN(RATED)}$		120		277	$V_{AC}$
Input Frequency	$f_{line}$		47	50/60	63	Hz
Input Current	$I_{IN}$	Full Load, $V_{IN} = 120V_{AC}$			0.6	A
Inrush Current	$I_{INRUSH}$	Cold Start, $V_{IN} = 277V_{AC}$			35	A
Leakage Current	$I_{Leakage}$	$V_{IN} = 277V_{AC}$ 60Hz			0.75	mA

Number of Drivers per MCB(Circuit Breaker)	MCB type	B10	C10	D10	B13	C13	D13	B16	C16	D16	B20	C20	D20
	120V <sub>AC</sub>	14	17	20	19	22	26	23	28	32	29	35	40
	277V <sub>AC</sub>	7	11	23	9	15	31	11	19	38	14	23	47

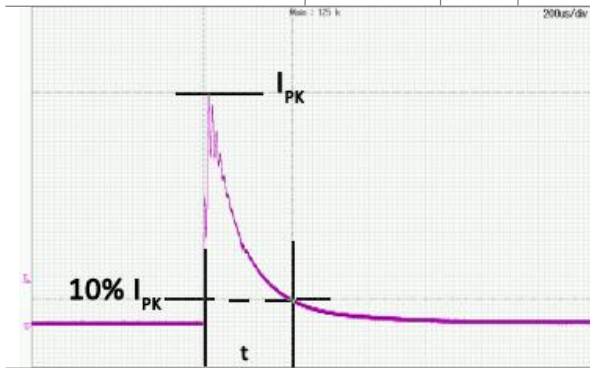

Input Voltage	Inrush Current	t(us)10%-10%
120VAC	14.3A	190
277VAC	33.5A	250
347VAC	NA	NA

### General Characteristics

Power Factor	PF	20-100% load, $V_{IN} = 120V_{AC}$	0.9		PF
		40-100% load, $V_{IN} = 277V_{AC}$	0.9		
Total Harmonic Distortion	THD	40-100%, $V_{IN} = 120-277V_{AC}$		20	%
Turn On Delay Time	$T_{on\_delay}$	Cold Start, 200-2000mA		0.5	S
Efficiency	$\eta$	Full load, $V_{IN}=120V_{AC}$ , $I_{OUT}=1000mA$ , Steady state	85	87	%
		Full load, $V_{IN}=277V_{AC}$ , $I_{OUT}=1000mA$ , Steady state	87	89	%

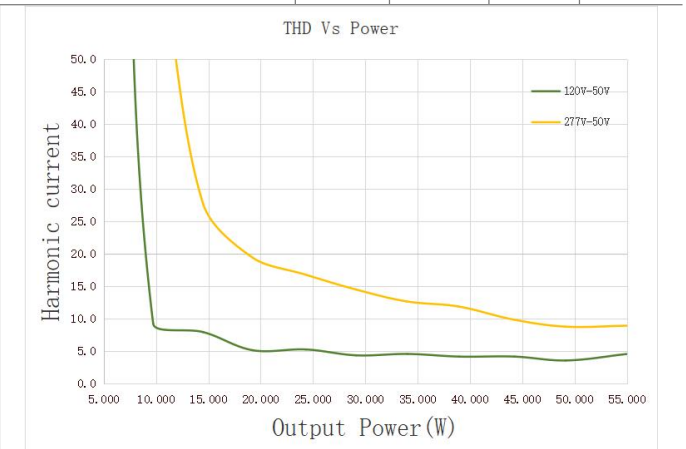
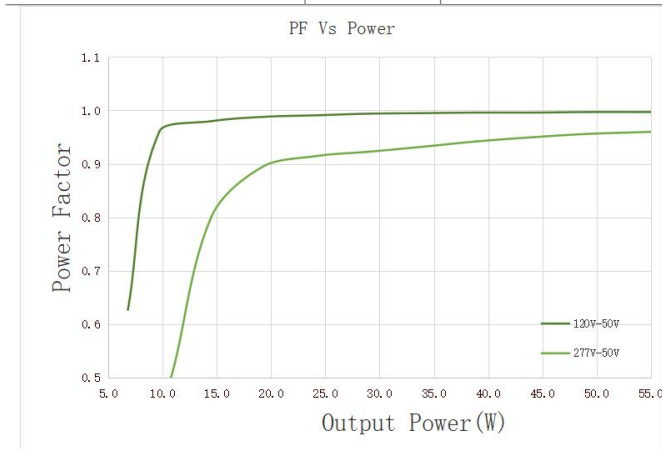

## OUTPUT

Programmable Output Current	$I_{OUT}$	Total Current	200	2000	mA
Output Current Tolerance	t	$I_{OUT}=600-2000mA$		5	%
		$I_{OUT}=200-599mA$		7	%
Output Current Range	$I_{OUT}$	Amplitude Control.	2	2000	mA
Output Voltage	$V_{OUT}$		10	55	V
Output Power	$P_{OUT}$	See "Operating window"		55	W
Line Regulation	$V_{OUT-LINE}$			1	%
Load Regulation	$I_{OUT-LOAD}$	$V_{OUT}$ from MIN. to MAX.		3.5	%
Ripple Current	$I_{OUT-RIPPLE}$	Full Load, $(I_{omax}-I_{omin})/(I_{omax}+I_{omin})$		10	%
Output Current Overshoot	$I_{OVERSHOOT}$	Turning Power ON		10	%

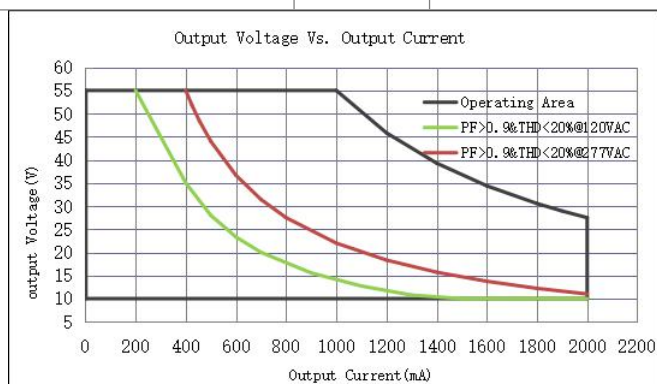



## Programming (Optional)

The driver can be programmed through RJ9.

- Output current(1mA step)
- Dim to off, Min Dimming Level
- Output voltage of aux power
- OTP point of driver, LED thermal protection
- End-of-life indicator
- Fade in time
- Over load protection point
- Log/linear/square dim curves
- Selectable for dimming mode: warm dim, tunable white,and solo dimming.

RJ9	The RJ9 port can recognize the type of input signal, analog or digital. So the driver can be easily connected to a digital control system, or can be connected to an external NTC / rheostat / current selection switch to set the driver(eg: output current , dimming level, and so on).				
	Programming software	"LUMIGEAR Programming Tool"			
	Programming tool	"Lumigear tool box"			
	Operating voltage		5	5.5	V
	Pull up resistor	RX are pulled up to +5V		15K	Ohm
		TX are pulled up to +5V		62K	Ohm
+5V Aux power			10	mA	

Programming Interface	PGT-USB-TPAC-A	
Programming Cables	PGT-USB-RJ9	

## 0~10V or Resistor Dimming

The 0~10V or resistor dimming can be used to dim the output current via a standard commercial wall dimmer (0~10V<sub>DC</sub>) or an external control voltage source (0~10V<sub>DC</sub>) or external resistor.

Dimming Curve	Linear. please see "Dimming curve".				
Absolute Maximum Voltage on 0~10V Pin	V <sub>DIM</sub>		0	300	V <sub>AC</sub>
Source Current on 0~10V Dimming Pin	I <sub>DIM</sub>		200		uA
Light On	V <sub>DIM-on</sub>	Programmable		0.9	V
Light Off	V <sub>DIM-off</sub>	Programmable		0.7	V
Dimming Voltage for Full Bright	V <sub>DIM-MAX</sub>	Programmable		8	V
External Resistor Value at Full Bright	R <sub>External</sub>			40	kΩ
Leakage Voltage	V <sub>Leak_rms</sub>	Voltage between DIM- and Ground		20	V <sub>AC</sub>
Standby power	P <sub>STANDBY</sub>	Light Off, Vin=120VAC		0.7	W

Figure 1: Intensity Dimming Profile Characteristics

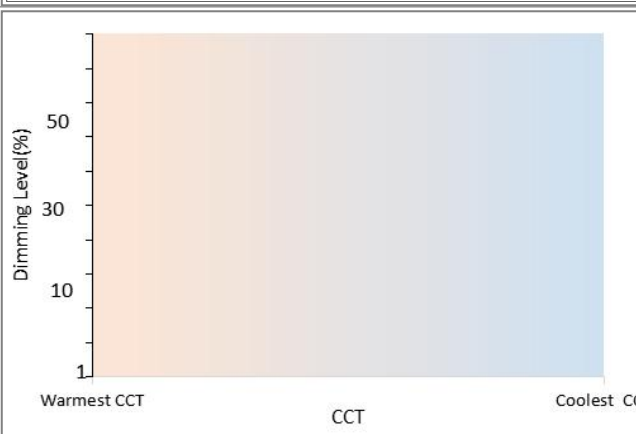
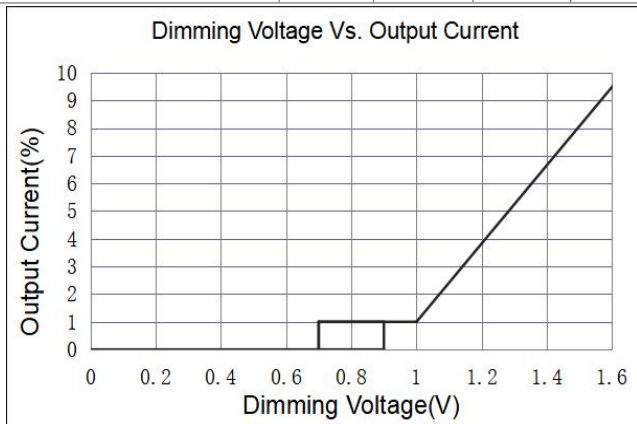
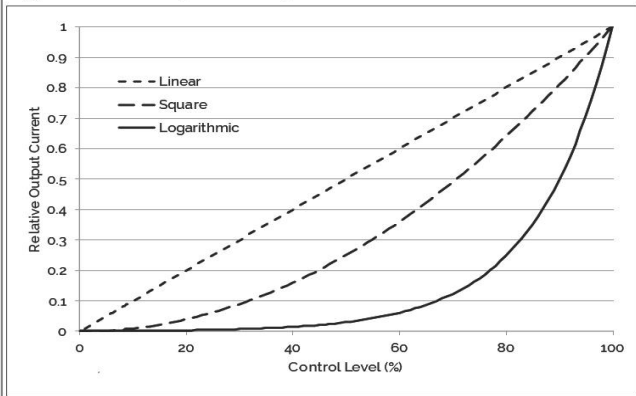

## INT(Output current) selection (Optional)

The output current can be set by the INT selection switch

Built-in INT selection switch | Settable, 3 positions

## CCT selection (Optional)

Build in CCT selection switch | Settable, 5CCT

## Auxiliary source (Optional)

Max.power	$P_{AUX}$				1	W
Voltage range	$V_{AUX}$	Programmable	12		24	Vdc
	$V_{AUX\_DEFAULT}$	Default voltage		12		Vdc
Voltage tolerance	$t_{AUX}$				8	%
Over load Protection	$P_{OLP\_AUX}$	Foldback mode			1.5	W

## LED Thermal Protection (NTC) Characteristic

Graphs for reference. The derating limits can be programmed using the Light Touch.

In the end application, care must be taken to place the NTC thermistor close to the hottest spot on the LED module.

If LED thermal protection is not required the NTC port on the LED power supply connector can be left open.

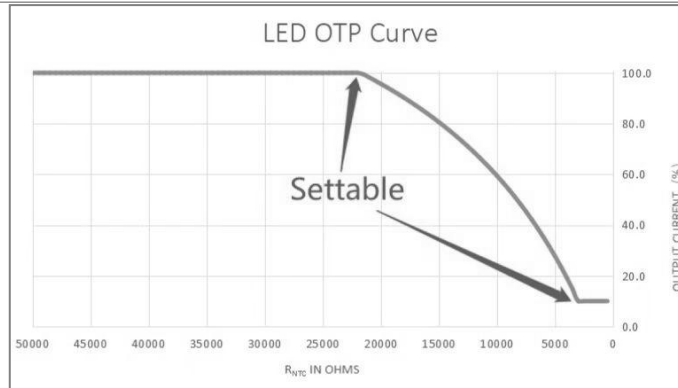

## Protection

Over Voltage Protection	$V_{OVP}$	The unit will recover automatically after fault conditions is removed.			60	V
Over load protection	$P_{OLP}$	Programmable. The output current will decrease when output power reach $P_{OLP}$	22		55	W
OLP tolerance	$t_{OLP}$		100		110	%
Over Temp. Protection	$T_{OTP}$	Programmable. Current foldback at hotspot greater than $T_{OTP}$		90		°C
Short Circuit Protection	The unit will recover automatically after fault conditions is removed.					

## Environment

Storage Temperature	$T_{Storage}$	Humidity: 5% RH to 95% RH	-40	-	+85	°C
Ambient Operating Temperature	$T_a$		-30	-	+50	°C
Max. Case Temperature	$T_c$	Hot spot on case			90	°C

Operating Relative Humidity	H <sub>a</sub>	Non-Condensing	10		90	%
Acoustic Noise		Measured from 1 m w/o dimmer.			24	dBA
Cooling	Convection Cooling					
IP Rating	Dry and damp UL approved					

## Others

Life Time	T <sub>Life</sub>	Full Load, 80°C case temperature,	50			kHrs
MTBF	T <sub>MTBF</sub>	Full Load, 25°C ambient temperature	200			kHrs
Net Weight	W <sub>NET</sub>			255		g
Warranty	5 Years Warranty at T <sub>c</sub> ≤80°C					
Flicker	IEEE 1789, title 24					

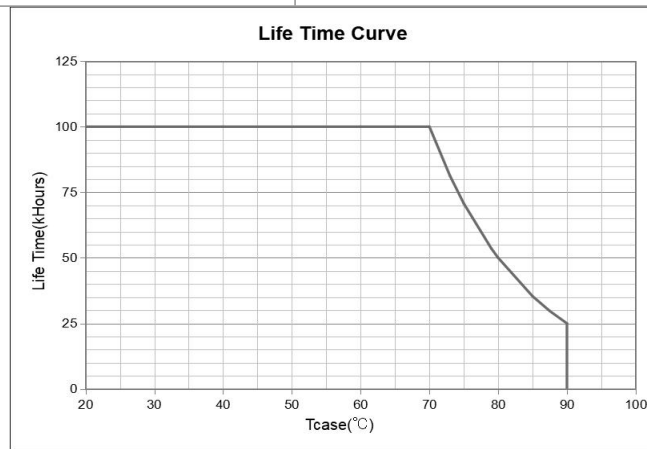

## Safety Compliance

CUL/UL	UL8750, CAN/CSA-C22.2 No. 250.13
LVD	EN61347

## Electromagnetic Compliance

EMC Requirements	Standard	Conditions
EMI Emissions	FCC Title 47 Part 15	Class B at 120V <sub>AC</sub> , Class A at 277V <sub>AC</sub>
Voltage Fluctuations and Flicker	IEC61000-3-3	
Immunity Compliance	IEC 61000-4-2	±8kV air Discharge, ±6kV Contact Discharge
	ANSI/IEEE C62.41-2002	± 2kV Common and Differential Mode, test at 2 Ω, 5 strikes/1minute interval (40 total strikes)
	ANSI/IEEE C62.41.1-2002	2.5kV Ring Wave, test at 30Ω 7 Strikes/1 minute interval, Common and Differential mode, 56 total strikes
	IEC 61000-4-11	>95% dip, .5 period; 30% dip, 25 periods; 95% reduction, 250 periods
	IEC 61000-4-4	± 2kV Direct couple to Line input, 5kHz repetition rate, 15mS duration, 300mS period. 7 coupling paths, 1 minute per path (14 total combinations)

Note: Unless otherwise specified, all the above parameters are measured at ambient temperature of 25°C and rated voltage.

## Typical Application

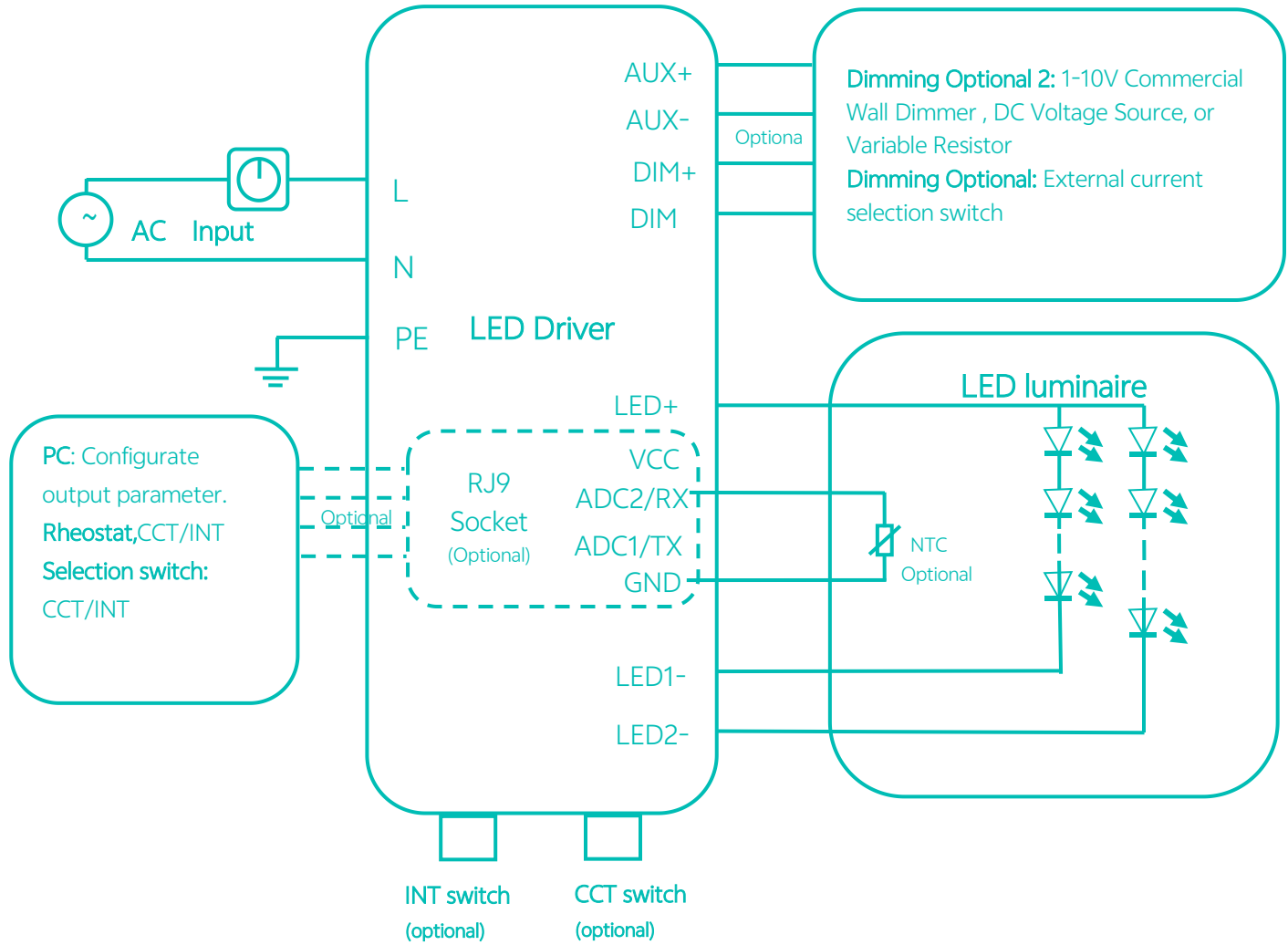

## Packaging

Driver quantity (pcs)	Layer	Weight (kg)	Outer dimensions of Carton L*W*H(mm)
48	6	12	L365*W340*H265

## Mechanical Drawing:

## S TYPE:

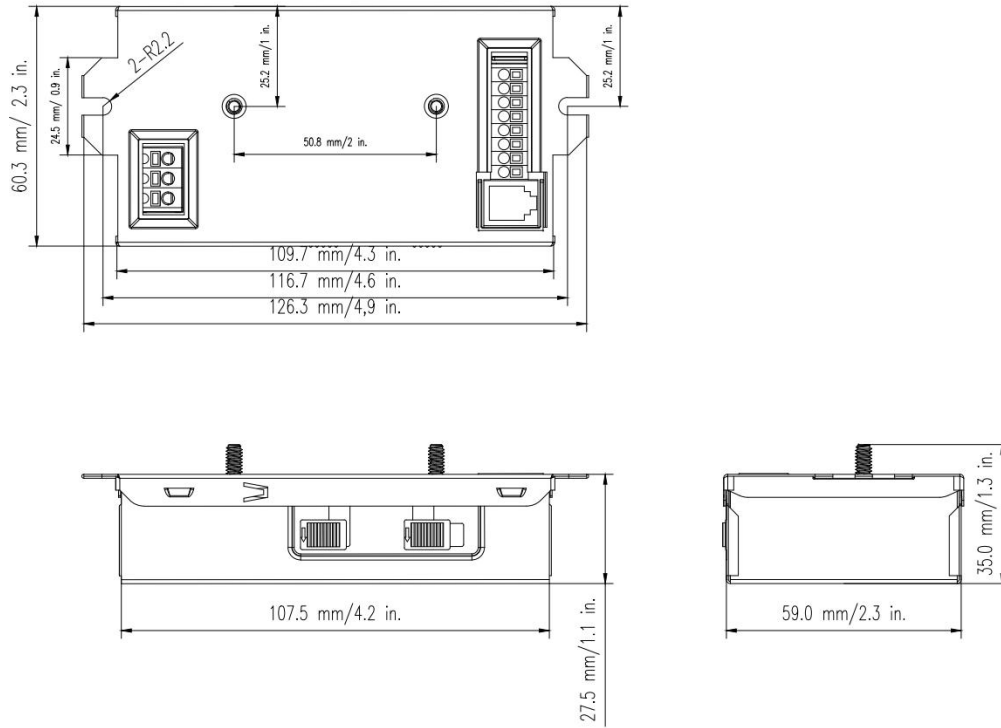

## M TYPE:

