

Features & Benefits

- Universal AC Input voltage(120-277VAC)
- Brick form factor, metal sheet case
- Isolated 0-10v dimming ,dim down to true 1%
- Suitable for indoor use
- Flicker free, excellent camera compatibility
- UL Class2, Class P
- Comply IEEE1789, UL8750

Programmable feature:

- ◆ Output current, dim to off, min dimming level, output voltage of aux power
- ◆ OTP point of driver, LED thermal protection, luminous decay compensation
- ◆ End-of-life indicator, fade in time, over load protection point

Model List

Model Name	Rated Input Voltage	Max Output Power(Total)	Output Current(Total)	Rated Output Voltage	Efficiency	Dimension
ESC-A1-012S0600U-V-AUX-PC-A-M	120-277VAC	12W max.	60-600mA	8-55VDC	85.5%	127*60.3*27.5 mm 5.0*2.3*1.1 in.

Optional Function

- Aux power: 12-24V programmable,1W
- Built-in 3 current adjustment by INT switch
- Built-in 3CCT switch
- Mounting feet or stud type
- Digital and analog interface ready

Approvals



Model name code

<u>ESC-A1</u>	=	<u>012S</u>	<u>0600</u>	<u>U</u>	=	<u>V</u>	=	<u>AUX</u>	=	<u>PC</u>	=	<u>A</u>	=	<u>M</u>
①		②	③	④		⑤		⑥		⑦		⑧		⑨

①	Series	ESC Series
②	Output power	Maximum output power: 12W
③	Output current(max)	Maximum output current: 600mA
④	Input voltage	120-277VAC
⑤	Dimming Control	0-10V
⑥	AUX	AUX: with Auxiliary source BLANK:without Auxiliary source
⑦	Programmable	USB-PC

⑧	Switch function	A: without INT and CCT Switch	B:with INT Switch only
		C: with CCT Switch only	D :with INT+CCT Switch.
⑨	Installation	M: Mounting feet BLANK:Stud type	

Specification:

Parameters	Symbols	Test Conditions / Comment	Min	Typ	Max	Units
------------	---------	---------------------------	-----	-----	-----	-------

INPUT

Input Voltage	V_{IN}		108		305	V_{AC}
Rated Input Voltage	$V_{INRATED}$		120		277	V_{AC}
Input Frequency	f_{line}		47	50/60	63	Hz
Input Current	I_{IN}	Full Load, $V_{IN} = 120V_{AC}$			0.14	A
Inrush Current	I_{INRUSH}	Cold Start, $V_{IN} = 277V_{AC}$			30	A
Leakage Current	$I_{Leakage}$	$V_{IN} = 277V_{AC}$ 60Hz			0.75	mA

Number of Drivers per MCB(Circuit Breaker)	MCB type	B10	C10	D10	B13	C13	D13	B16	C16	D16	B20	C20	D20
	120V _{AC}	17	28	57	22	37	75	27	46	92	34	57	115
	277V _{AC}	9	15	31	12	20	40	15	25	50	18	31	62



Input Voltage	Inrush Current	t(us)10%-10%
120VAC	12.1A	200
277VAC	25.5A	190
347VAC	NA	NA

General Characteristics

Power Factor	PF	50-100% load, $V_{IN} = 120V_{AC}$	0.95		PF
		70-100% load, $V_{IN} = 277V_{AC}$	0.9		
Total Harmonic Distortion	THD	50-100% load, $V_{IN} = 120V_{AC}$		20	%
		70-100% load, $V_{IN} = 277V_{AC}$		20	%
Turn On Delay Time	T_{on_delay}	Cold Start, 60-600mA		0.5	S
Efficiency	η	Full load, $V_{IN} = 120V_{AC}$, $I_{OUT} = 300mA$, Steady state	84	85.5	%
		Full load, $V_{IN} = 277V_{AC}$, $I_{OUT} = 300mA$, Steady state	83	84.5	%

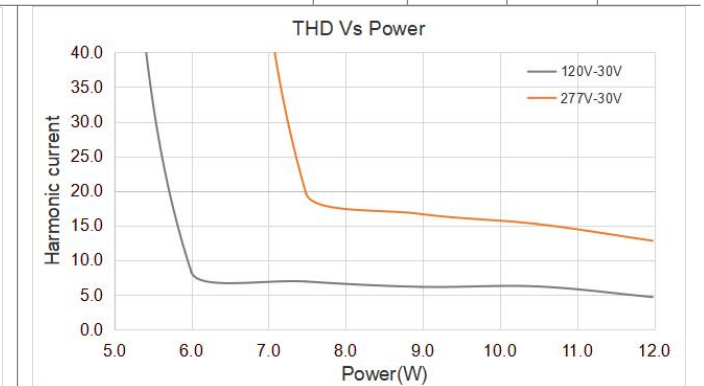
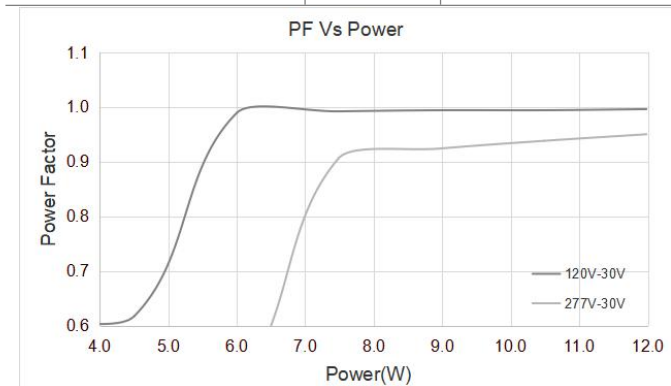



OUTPUT

Programmable Output Current	I _{OUT}		60		600	mA
Output Current Tolerance	t	I _{OUT} =150-600mA			5	%
		I _{OUT} =60-149mA			7	%
Output Current Range	I _{OUT}	Amplitude Control.	0.6		600	mA
Output Voltage	V _{OUT}		8		55	V
Output Power	P _{OUT}	See "Operating window"			12	W
Line Regulation	V _{OUT-LINE}				1	%
Load Regulation	I _{OUT-LOAD}	V _{OUT} from MIN. to MAX.			3.5	%
Ripple Current	I _{OUT-RIPPLE}	Full Load, (I _{omax} -I _{omin})/(I _{omax} +I _{omin})			10	%
Output Current Overshoot	I _{OVERSHOOT}	Turning Power ON			10	%

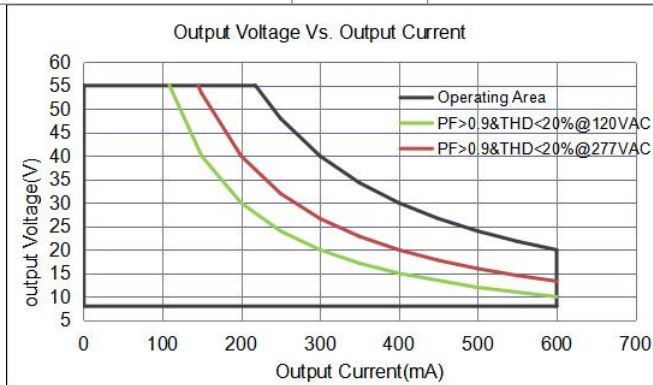



Programming (Optional)

The driver can be programmed through RJ9.

- Output current(1mA step)
- Dim to off, Min Dimming Level
- Output voltage of aux power
- OTP point of driver
- LED thermal protection
- Luminous decay compensation
- End-of-life indicator

- Fade in time
- Over load protection point

	The RJ9 port can recognize the type of input signal, analog or digital. So the driver can be easily connected to a digital control system, or can be connected to an external NTC / rheostat / current selection switch to set the driver(eg: output current , dimming level, and so on).					
RJ9	Programming software	“LUMIGEAR Programming Tool”				
	Programming tool	“Lumigear tool box”				
	Operating voltage			5	5.5	V
	Pull up resistor	RX is pulled up to +5V		15K		Ohm
		TX is pulled up to +5V		62K		Ohm
+5V Aux power				10	mA	
Programming Interface	PGT-USB-TPAC-A					
Programming Cables	PGT-USB-RJ9					

0~10V or Resistor Dimming

The 0~10V or resistor dimming can be used to dim the output current via a standard commercial wall dimmer (0~10V_{dc}) or an external control voltage source (0~10V_{dc}) or external resistor.

Dimming Curve	Linear. please see “Dimming curve”.					
Absolute Maximum Voltage on 0~10V Pin	V_{DIM}		0		300	V_{AC}
Source Current on 0~10V Dimming Pin	I_{DIM}			200		μA
Light On	V_{DIM-on}	Programmable		0.9		V
Light Off	$V_{DIM-off}$	Programmable		0.7		V
Dimming Voltage for Full Bright	$V_{DIM-MAX}$	Programmable		8		V
Leakage Voltage	$V_{Leak-rms}$	Voltage between DIM- and Ground			20	V_{AC}
Standby power	$P_{STANDBY}$	Light Off, Vin=120VAC			0.7	W

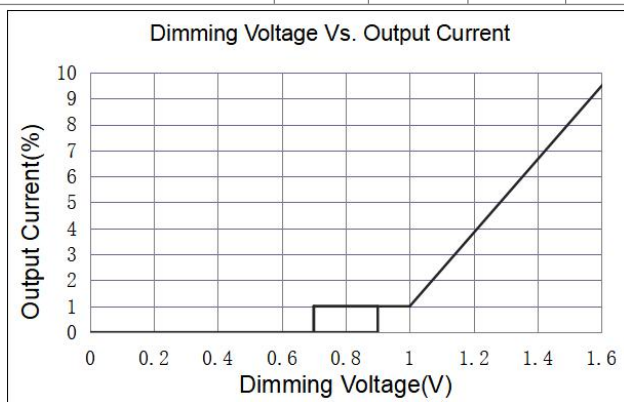
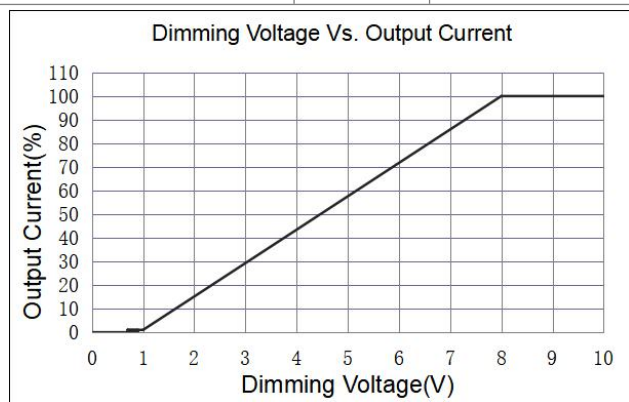

INT(Output current) selection (Optional)

The output current can be set by the INT selection switch

Built-in INT selection switch	Settable, 3 positions, Please contact Lumigear for details
-------------------------------	--

CCT selection (Optional)

Build in CCT selection switch	CCT1=CH1 on, CH2 off
	CCT2=CH1 on, CH2 on
	CCT3=CH1 off, CH2 on

Auxiliary source (Optional)

Max.power	P_{AUX}				1	W
Voltage range	V_{AUX}	Programmable	12		24	Vdc
	$V_{AUX_DEFAULT}$	Default voltage		12		Vdc
Voltage tolerance	t_{AUX}				8	%
Over load Protection	P_{OLP_AUX}	Foldback mode			1.5	W

LED Thermal Protection (NTC) Characteristic

Graphs for reference. The derating limits can be programmed using the Light Touch.

In the end application, care must be taken to place the NTC thermistor close to the hottest spot on the LED module.

If LED thermal protection is not required the NTC port on the LED power supply connector can be left open.

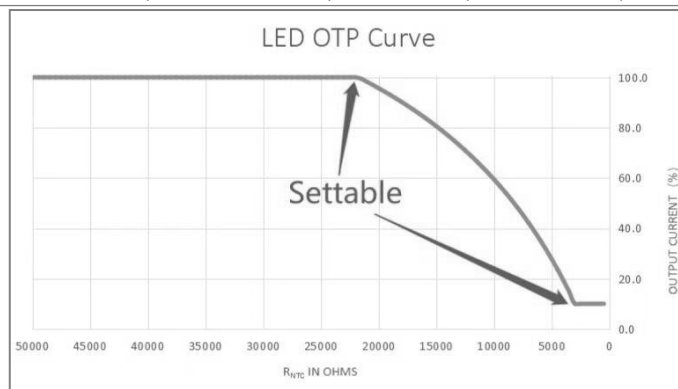

Protection

Over Voltage Protection	V_{OVP}	The unit will recover automatically after fault conditions is removed.			60	V
Over load protection	P_{OLP}	Programmable. The output current will decrease when output power reach P_{OLP}	4.8		12	W
OLP tolerance	t_{OLP}		110		120	%
Over Temp. Protection	T_{OTP}	Programmable. Current foldback at hotspot greater than T_{OTP}		80		°C
Short Circuit Protection	The unit will recover automatically after fault conditions is removed.					

Environment

Storage Temperature	$T_{Storage}$	Humidity: 5% RH to 95% RH	-40	-	+85	°C
Ambient Operating Temperature	T_a		-30	-	+50	°C
Max. Case Temperature	T_c	Hot spot on case			80	°C
Operating Relative Humidity	H_a	Non-Condensing	10		90	%
Acoustic Noise		Measured from 1 m w/o dimmer.			24	dBA
Cooling	Convection Cooling					
IP Rating	Dry and damp UL approved					

Others

Life Time	T_{Life}	Full Load, 70°C case temperature,	50			kHrs
MTBF	T_{MTBF}	Full Load, 25°C ambient temperature	200			kHrs
Net Weight	W_{NET}			200		g
Warranty	5 Years Warranty at $T_c \leq 70^\circ\text{C}$					
Flicker	IEEE 1789, title 24					

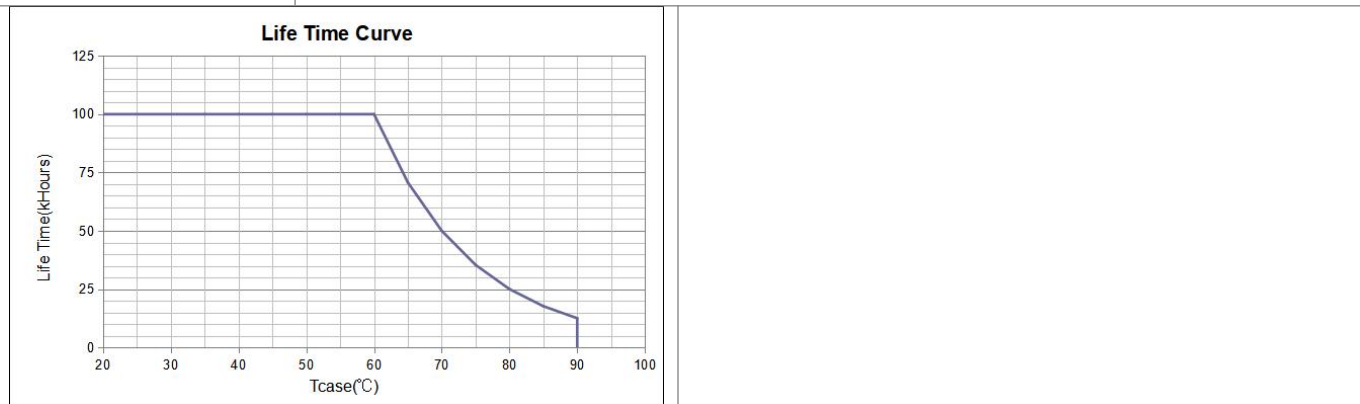

Safety Compliance

CUL/UL	UL8750, CAN/CSA-C22.2 No. 250.13
LVD	EN61347

Electromagnetic Compliance

EMC Requirements	Standard	Conditions
EMI Emissions	FCC Title 47 Part 15	Class B at 120V _{AC} , Class A at 277V _{AC}
Voltage Fluctuations and Flicker	IEC61000-3-3	
Immunity Compliance	IEC 61000-4-2	±8kV air Discharge, ±6kV Contact Discharge
	ANSI/IEEE C62.41-2002	± 2kV Common and Differential Mode, test at 2 Ω, 5 strikes/1minute interval (40 total strikes)
	ANSI/IEEE C62.41.1-2002	2.5kV Ring Wave, test at 30Ω 7 Strikes/1 minute interval, Common and Differential mode, 56 total strikes

IEC 61000-4-11	>95% dip, .5 period; 30% dip, 25 periods; 95% reduction, 250 periods
IEC 61000-4-4	± 2kV Direct couple to Line input, 5kHz repetition rate, 15mS duration, 300mS period. 7 coupling paths, 1 minute per path (14 total combinations)

Note: Unless otherwise specified, all the above parameters are measured at ambient temperature of 25°C and rated voltage.

Typical Application

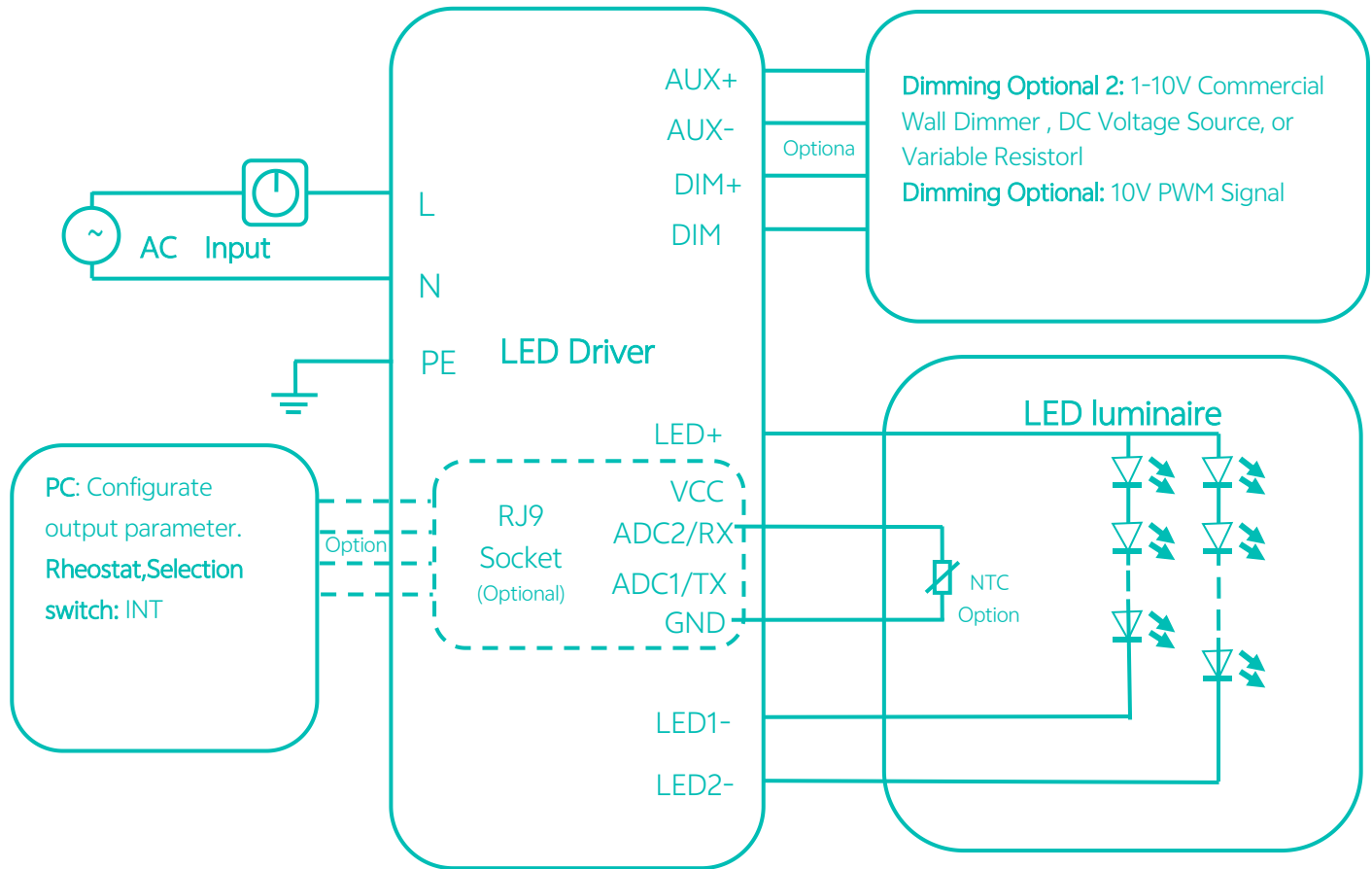

Packaging

Driver quantity (pcs)	Layer	Weight (kg)	Outer dimensions of Carton L*W*H(mm)
48	6	13	L365*W340*H270

Mechanical Drawing:

S TYPE:

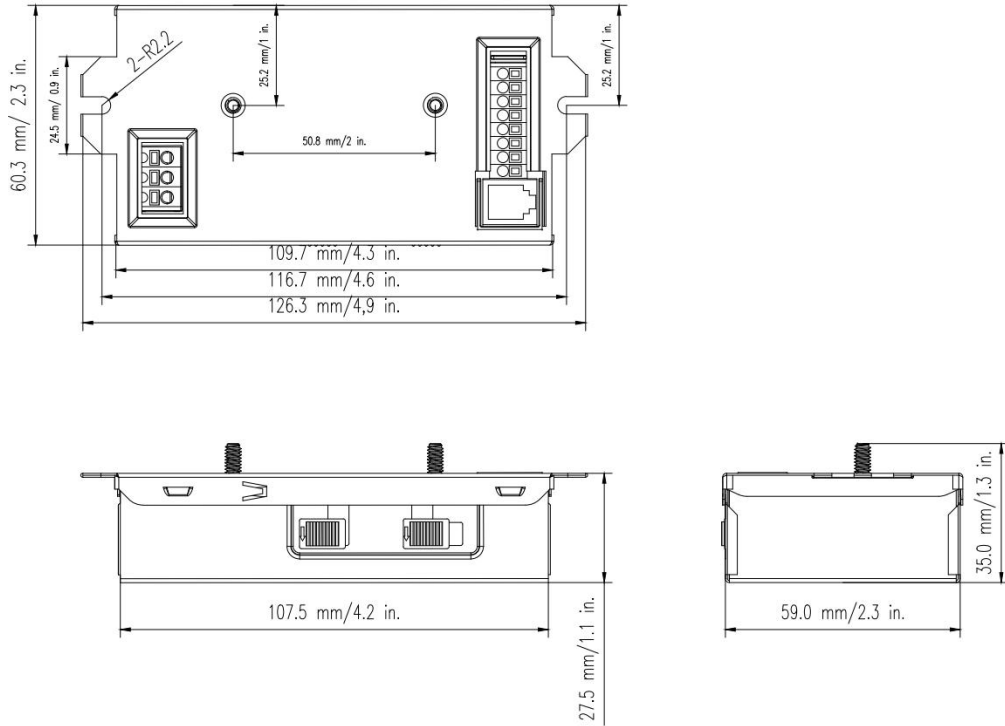

M TYPE:

