



LUMIGEAR
AFP-C1-012S0400U-VT-PC-S
 Constant Current LED Driver

Input:120-277V_{ac} 50/60Hz 0.14A_{max}
 Output:10-40V_{dc} 0.04A-0.4A(settable) 12W_{max}

Class 2
 Class P
 0-10V Dimming
 Programmable
 TRIAC Dimming@120V_{ac}

FC RoHS UL LISTED

CAUTION:
 For connections use wire rated for at least 90°C (194°F).
 Disconnect line voltage before installing or replacing.
 Dry or damp locations only.
 Dimming input is isolated Class 2 or non-Class 2 wiring allowed.
 Ground enclosure in installation.

Made in Vietnam

Features & Benefits

- Universal AC input voltage(120-277VAC)
- High power density design, white aluminum sheet metal case
- Comply with phase cut dimming and isolated 0-10V dimming, dim down to true 1%
- Suitable for indoor use
- Flicker free, excellent camera compatibility
- UL Class2, Class P
- Combination Wave 2KV, Ringwave 2.5KV
- Operating temperature: -25°C~+50°C

Programmable feature:

- ◆ Output current(1ma step)
- ◆ Dim to off, min dimming level
- ◆ Programmable conduction angles with turn-on & turn-off for triac & elv
- ◆ Dimming curve: Log/linear/customer
- ◆ OTP mode: Foldback mode, linear decrease mode
- ◆ Over load protection
- ◆ Dimming fade time

Model List

Model Name	Rated Input Voltage	Max Output Power(Total)	Output Current(Total)	Rated Output Voltage	Efficiency	Dimension
AFP-C1-012S0400U-VT-PC-S	120-277VAC	12W max.	40-400mA	10-40VDC	85%	112*31*23mm/4.4*1.2*0.9 in. 98*31*23 mm/3.8*1.2*0.9 in.

Optional Function

Side feed and bottom feed

Approvals

TRIAC 0/1-10 V  CLASS P

Model name code

AFP-C1	-	012S	0400	U	-	VT	-	PC	-	X
①		②	③	④		⑤		⑥		⑦

①	Series	AFP Series
②	Output power	Maximum output power: 12W
③	Output current(max)	Maximum output current: 400mA
④	Input voltage	120-277VAC
⑤	Dimming Control	Triac&0-10V
⑥	Programmable	USB-PC
⑦	Feed	S= side feed B= bottom feed

Specification:

Parameters	Symbols	Test Conditions / Comment	Min	Typ	Max	Units							
INPUT													
Input Voltage	V_{IN}		108		305	V_{AC}							
Rated Input Voltage	$V_{IN RATED}$		120		277	V_{AC}							
	$V_{IN RATED_TRIAC}$	Phase Cut Dimming		120		V_{AC}							
Input Frequency	f_{line}		47	50/60	63	Hz							
Input Current	I_{IN}	Full Load, $V_{IN} = 120V_{AC}$			0.14	A							
Inrush Current	I_{INRUSH}	Cold Start, $V_{IN} = 277V_{AC}$			18	A							
Leakage Current	$I_{Leakage}$	$V_{IN} = 277V_{AC}$ 60Hz			0.75	mA							
Number of Drivers per MCB(Circuit Breaker)	MCB type	B10	C10	D10	B13	C13	D13	B16	C16	D16	B20	C20	D20
	120V _{AC}	26	43	66	34	56	85	42	70	105	52	87	132
	277V _{AC}	15	25	50	19	32	65	24	40	81	30	50	101

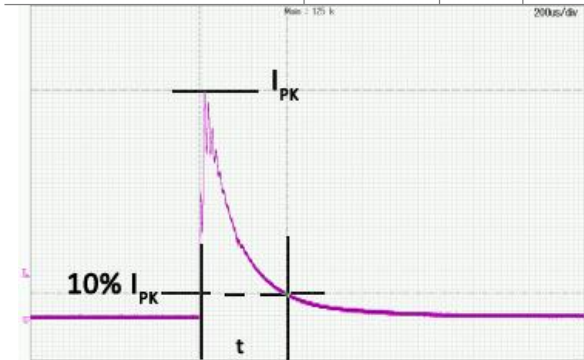

Input Voltage	Inrush Current	t(us)10%-10%
120VAC	8.0A	254
277VAC	15.8A	208
347VAC	NA	NA

General Characteristics

Power Factor	PF	30-100% load, $V_{IN} = 120V_{AC}$	0.9		PF
		60-100% load, $V_{IN} = 277V_{AC}$	0.9		
Total Harmonic Distortion	THD	30-100% load, $V_{IN} = 120V_{AC}$		20	%
		60-100% load, $V_{IN} = 277V_{AC}$		20	%
Turn On Delay Time	T_{on_delay}	Cold Start, Without Dimmer		0.5	S
Efficiency	η_{120V}	Full load, $V_{IN}=120V_{AC}$, $I_{OUT}=300mA$, Steady state	83	85	%
	η_{277V}	Full load, $V_{IN}=277V_{AC}$, $I_{OUT}=300mA$, Steady state	81	83	%

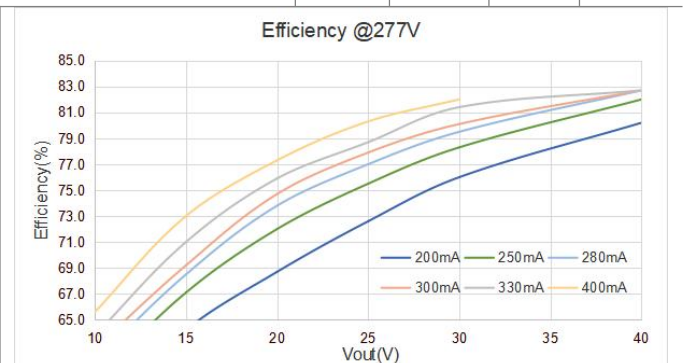
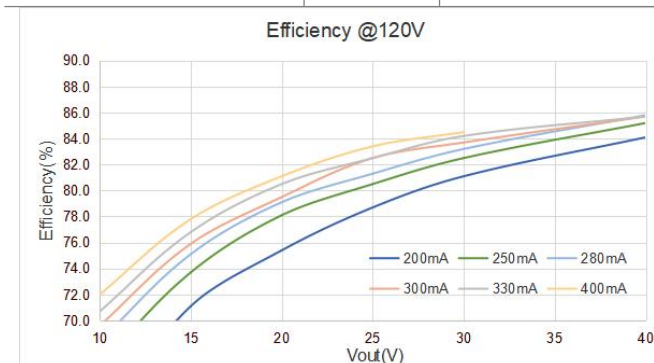

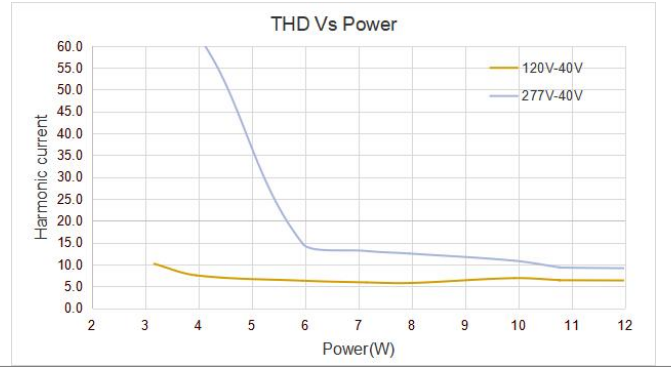
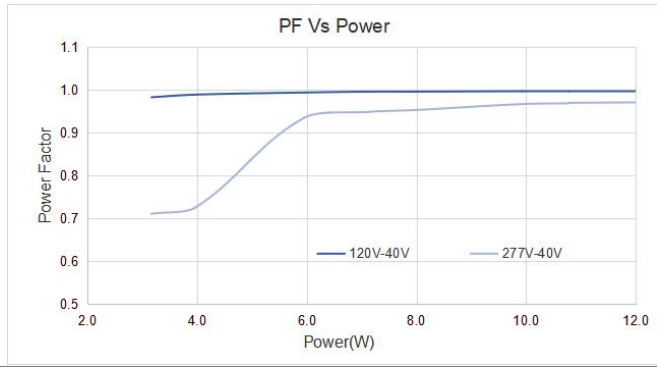

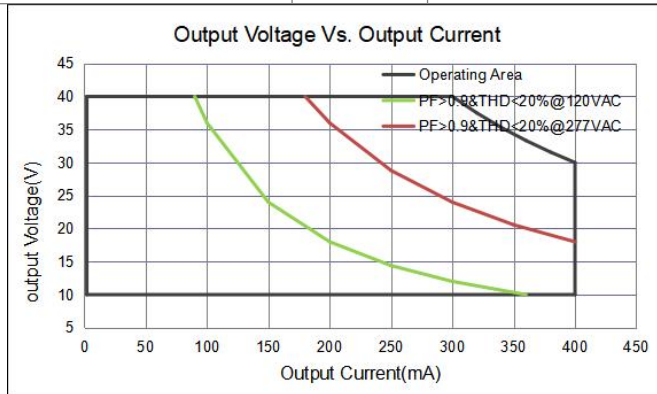

OUTPUT

Output Current Tolerance	t	$I_{OUT}=(40-100\%)I_{MAX}$		5	%
		$I_{OUT}=(10-39\%)I_{MAX}$		7	%
Output Current Range	I_{OUT}		0.4	400	mA
Line Regulation	$V_{OUT-LINE}$			1	%
Load Regulation	$I_{OUT-LOAD}$	V_{OUT} from MIN. to MAX.		5	%
Ripple Current	$I_{OUT-RIPPLE}$	Full Load, $(I_{omax}-I_{omin})/(I_{omax}+I_{omin})$		10	%
Output Current Overshoot	$I_{OVERSHOOT}$	Turning Power ON		10	%



Programming

NO.	Item	Default Setting
1	Output current(1mA step)	See"Model list" for each model
2	Dim to off(0-10V)	Enable
3	Min Dimming Level	1%
4	0-10V Dimming curve: Log/linear/customer dim curves	See "0~10V or Resistor Dimming" section
5	Over Temperature Protection: Foldback mode, Linear decrease mode	See "Protection" section
6	Over load protection	See "Protection" section
7	Fade time	10mS

Programming Interface	PGT-USB-TPAC-A	
Programming Cables	PGT-USB-AUDIO	

0~10V or Resistor Dimming

The 0~10V or resistor dimming can be used to dim the output current via a standard commercial wall dimmer (0~10V_{DC}) or an external control voltage source (0~10V_{DC}) or external resistor.

Dimming Curve	Selectable: Log/linear/customer, Default setting is linear curve. please see “Dimming curve”.				
Absolute Maximum Voltage on 0~10V Pin	V _{DIM}			300	V _{AC}
Source Current on 0~10V Dimming Pin	I _{DIM}		200		uA
Light On	V _{DIM-on}	Programmable		0.9	V
Light Off	V _{DIM-off}	Programmable		0.7	V
Dimming Voltage for Full Bright	V _{DIM-MAX}	Programmable		8	V
Leakage Voltage	V _{Leak_rms}	Voltage between DIM- and Ground		20	V _{AC}
Standby power	P _{STANDBY}	Light Off		0.6	W

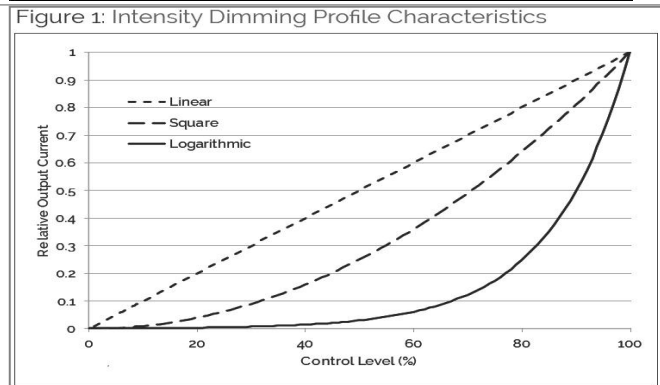
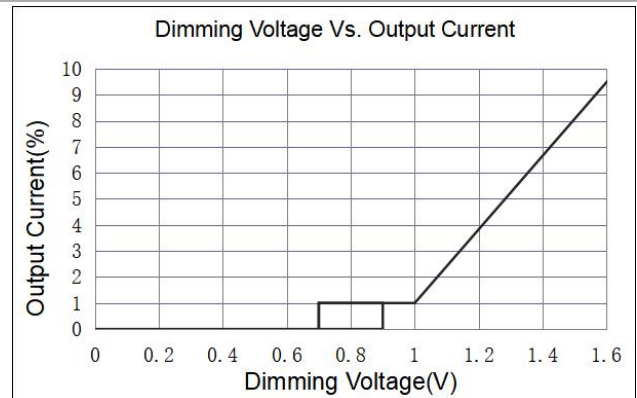
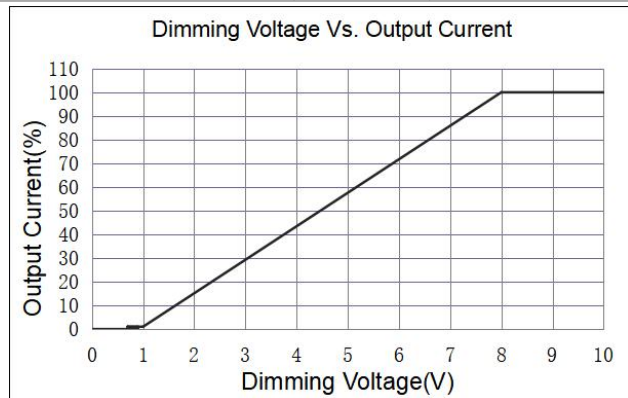

Triac Dimming

The unit is compatible With Leading-edge and Trailing-edge Dimmer.

Input Voltage	V _{IN-TRIAC DIM}		120		V _{AC}
Suggest Load Range	P _{Suggest}	V _{IN} = 120 V _{AC}	60	100	%

Protection

Over Voltage Protection	V_{OVP}	The unit will recover automatically after fault conditions is removed.	60		V
Over Temp. Protection	T_{OTP}	Current foldback at hotspot greater than T_{OTP}	95		°C
Over load protection	P_{OLP}	Programmable. Output current will decrease when output power reach P_{OLP}	6	15	W
OLP tolerance	t_{OLP}		100	110	%
Short Circuit Protection	The unit will recover automatically after fault conditions is removed.				

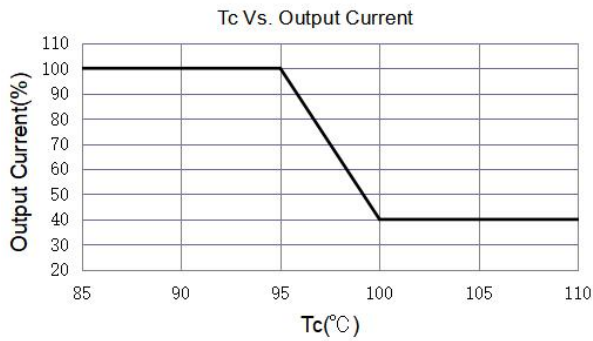

Environment

Storage Temperature	$T_{Storage}$	Humidity: 5% RH to 95% RH	-40	-	+85	°C
Ambient Operating Temperature	T_a		-25	-	+50	°C
Max. Case Temperature	T_c	Hot spot on case			90	°C
Operating Relative Humidity	H_a	Non-Condensing	10	90	%	
Acoustic Noise		Measured from 1 m w/o dimmer.		24	dBA	
Cooling	Convection Cooling					
IP Rating	Dry and damp UL approved					

Others

Life Time	T_{Life}	Full Load, 80°C case temperature,	50			kHrs
MTBF	T_{MTBF}	Full Load, 25°C ambient temperature	200			kHrs
Net Weight	W_{NET}			135		g
Warranty	5 Years Warranty at $T_c \leq 80^\circ\text{C}$					
Flicker	IEEE 1789, title 24					

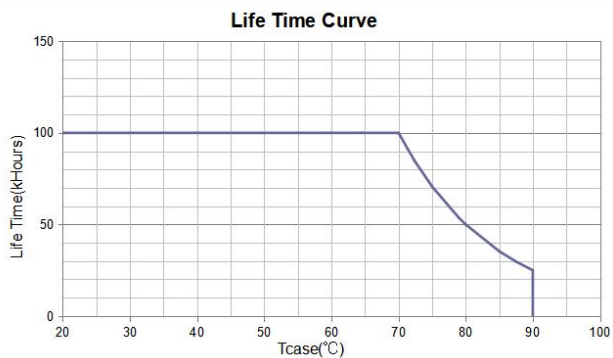

Safety Compliance

CUL/UL	UL8750, CAN/CSA-C22.2 No. 250.13
--------	----------------------------------

Electromagnetic Compliance

EMC Requirements	Standard	Conditions
EMI Emissions	FCC Title 47 Part 15	Class B at 120V _{AC} , Class A at 277V _{AC}
Voltage Fluctuations and Flicker	IEC61000-3-3	
Immunity Compliance	IEC 61000-4-2	±8kV air Discharge, ±6kV Contact Discharge
	ANSI/IEEE C62.41-2002	± 2kV Common and Differential Mode, test at 2 Ω, 5 strikes/1minute interval (40 total strikes)
	ANSI/IEEE C62.41.1-2002	2.5kV Ring Wave, test at 30 Ω 7 Strikes/1 minute interval, Common and Differential mode, 56 total strikes
	IEC 61000-4-11	>95% dip, 5 period; 30% dip, 25 periods; 95% reduction, 250 periods
	IEC 61000-4-4	± 2kV Direct couple to Line input, 5kHz repetition rate, 15mS duration, 300mS period. 7 coupling paths, 1 minute per path (14 total combinations)

Note: Unless otherwise specified, all the above parameters are measured at ambient temperature of 25°C and rated voltage.

Compatible Phase Cut Dimmers:

No.	Mfg.	Model	Remark	No.	Mfg.	Model	Remark
1	Lutron	MACL-153M		12	Leviton	1B34L1	
2	Lutron	LGCL-153PL		13	Leviton	IPL06	
3	Lutron	GLU12-F23622		14	Leviton	SureSlide 6633	
4	Leviton	111506		15	Leviton	IPE04	
5	Lutron	GLV-600		16	Leviton	IPL06-102	
6	Lutron	D-600P		17	Lutron	DVCL-153P	
7	Lutron	DVLV-600P		18	Legrand	LSLV603	
8	Lutron	MALV-600		19	Legrand	RHCL453P	
9	Lutron	NT-1000		20	Lutron	1K35O2	
10	Lutron	SLV-600P		21	Lutron	DV-600P	
11	Lutron	MA-600					

Typical Application

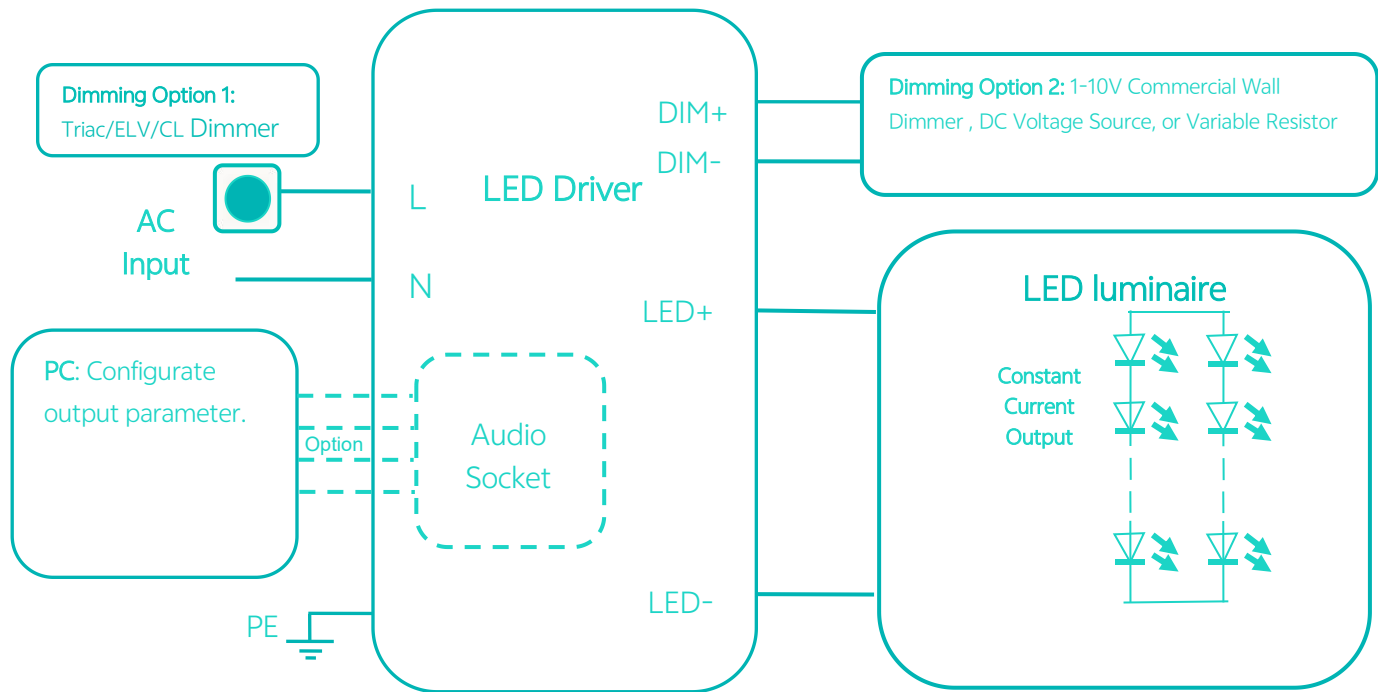

Packaging

Driver quantity (pcs)	Layer	Weight (kg)	Outer dimensions of Carton L*W*H(mm)
80	10	12.5	L365*W340*H270

Mechanical Drawing:

